

STORAGE IN APPROVED MAGAZINES OF COMPLETE ROUND, AIM-4F OR 4G (FALCON) IN EGSC-3A CONTAINER (PALLETIZED)

INDEX

<u>ITEM</u>	<u>PAGE (S)</u>
GENERAL NOTES -----	2
DETAIL OF PALLET UNIT -----	3
STORAGE PROCEDURES (EARTH-COVERED MAGAZINES):	
81'-0" AND 60'-8" X 26'-6" W X 12'-9" H IGLOO MAGAZINES -----	4, 5
81'-2" L X 26'-6" W X 12'-1-3/4" H ARCH TYPE MAGAZINE (IGLOO) -----	6, 7
80'-0" AND 40'-0" L X 25'-0" W X 12'-1-3/4" H ARCH TYPE MAGAZINES (IGLOO) -----	8, 9
80'-0" AND 40'-0" L X 25'-0" W X 11'-0" H ARCH TYPE MAGAZINES (IGLOO) -----	10, 11
80'-0" AND 40'-0" L X 25'-0" W X 10'-0" H ARCH TYPE MAGAZINES (IGLOO) -----	12, 13
80'-0" L X 25'-0" W X 14'-0" H STRADLEY AND 89'-0" L X 24'-10" W X 14'-4" H OVAL ARCH MAGAZINES -----	14, 15
52'-0" DIAMETER AND 44'-7" DIAMETER CORBETTA MAGAZINES -----	16, 17
100'-8" L X 50'-0" W RECTANGULAR MAGAZINE -----	18, 19

REVISIONS				DRAFTSMAN	PROJ ENG
				bh	ESH/MLL
				CHECKER	LOG ENGRG OFFICE
				W. E. Smith	
APPROVED, U. S. ARMY ARMAMENT, MUNITIONS AND CHEMICAL CENTER					
<i>Keith Robertson</i>					
APPROVED BY ORDER OF COMMANDING GENERAL, U. S. ARMY MATERIEL DEVELOPMENT AND READINESS COMMAND (DARCOM)					
<i>John T. Synell</i>					
U. S. ARMY DEFENSE AMMUNITION CENTER AND SCHOOL					
U. S. ARMY DARCOM DRAWING					
JANUARY 1984					
CLASS	DIVISION	DRAWING	FILE		
19	48	7059/IC	SPI-3-4 14-22 PM-2		

DO NOT SCALE

PROJECT SP 1101C-78

GENERAL NOTES

- A. THIS DOCUMENT HAS BEEN PREPARED AND ISSUED IN ACCORDANCE WITH AR 740-1 AND AUGMENTS TM 743-200-1 (CHAPTER 5).
- B. THE STORAGE PROCEDURES SPECIFIED IN THIS DRAWING ARE APPLICABLE TO THE COMPLETE ROUND, AIM-4F OR 4G (FALCON) PACKED ONE (1) PER EGSC-3A METAL SHIPPING AND STORAGE CONTAINER (PALLETIZED). SUBSEQUENT REFERENCE TO PALLET UNIT MEANS THE PALLETIZED UNIT OF FOUR (4) CONTAINERS WITH CONTENTS.
- C. FOR DETAILS OF THE EGSC-3A CONTAINER, SEE T.O. 35E20-2-7-2-, HUGHES AIRCRAFT CO. DRAWING NO. 205036, AND THE PALLET UNIT DETAIL ON PAGE 3.
- PALLET UNIT DIMENSIONS --- 94-5/8" LONG BY 48" WIDE BY 53-1/2" HIGH.
GROSS WEIGHT ----- 1,242 POUNDS (APPROX).
CUBE ----- 140.66 CU. FT. (APPROX).
- D. FOR QUANTITY DISTANCE AND COMPATIBILITY GROUP OF THIS ITEM, SEE T.O. 11A-1-46. **CAUTION:** THIS ITEM IS IN A "PROPULSIVE STATE" AND MUST BE STORED WITH THE FORWARD END FACING TOWARD ONE SIDE WALL AND/OR THE REAR WALL AS INDICATED BY THE DIRECTIONAL ARROWS ON THE STORAGE VIEWS.
- E. THE STORAGE PROCEDURES DEPICTED WITHIN THIS DOCUMENT ARE APPLICABLE FOR STORAGE IN VARIOUS TYPES AND SIZES OF MAGAZINES. THE STORAGE PROCEDURES DEPICTED FOR THE SPECIFIC TYPES OF MAGAZINES MAY ALSO BE UTILIZED TO STORE PALLET UNITS IN OTHER TYPES OF APPROVED MAGAZINES. MINOR ADJUSTMENTS MAY BE MADE TO FACILITATE STORAGE IN OTHER TYPES OF MAGAZINES; HOWEVER, THE BASIC PRINCIPLES AS DEPICTED HEREIN WILL BE FOLLOWED.
- F. AISLE DIMENSIONS AS SHOWN HEREIN MAY BE ADJUSTED TO SUIT LOCAL CONDITIONS AND/OR AVAILABLE MATERIAL HANDLING EQUIPMENT (MHE); HOWEVER, AN 18" MINIMUM INSPECTION AISLE MUST BE MAINTAINED AT THE AFT END OF THE CONTAINER STACKS WHERE THE HUMIDITY INDICATORS ARE LOCATED.
- G. **CAUTION:** THE ALLOWABLE "EXPLOSIVE LIMIT" ESTABLISHED FOR A MAGAZINE IS NOT TO BE EXCEEDED. THIS LIMITATION MAY REQUIRE A QUANTITY REDUCTION FROM THE STORAGE AS SHOWN.
- H. IF AVAILABLE MHE PERMITS, ADDITIONAL PALLET UNITS MAY BE STORED WITHIN THE FRONTAL AREA AND/OR OTHER AVAILABLE AREA OF THE MAGAZINE.
- J. STORED PALLET UNITS MUST NOT CONTACT THE WALLS OF A MAGAZINE. TO PROVIDE FOR THIS MANDATORY CLEARANCE REQUIREMENT, PALLET UNITS MAY BE ELIMINATED FROM THE DEPICTED STORAGE PATTERN AS NECESSARY.
- K. OTHER COMPATIBLE ITEMS MAY BE STORED IN A MAGAZINE WHICH IS PARTIALLY FILLED WITH THE DESIGNATED ITEM.
- L. PORTIONS OF THE MAGAZINES, SUCH AS THE SIDEWALLS, END WALLS, AND ROOFS, HAVE NOT BEEN SHOWN IN THE STORAGE VIEWS FOR CLARITY PURPOSES.
- M. IF THE QUANTITY OF PALLET UNITS FOR A MAGAZINE IS TO BE REDUCED FROM WHAT IS SHOWN HEREIN, THE DELINEATED PROCEDURES ARE TO BE ADJUSTED BY OMITTING STACKS RATHER THAN OMITTING LAYERS.
- N. ANY PALLET UNIT THAT DOES NOT CONSIST OF A FULL QUANTITY OF CONTAINERS WILL NOT BE BURIED IN STORAGE. IT MUST BE POSITIONED ADJACENT TO AN AISLE, PREFERABLY IN FRONT OF THE LOT.
- O. USE FORK TINE EXTENSIONS AND A FORKLIFT TRUCK OF SUFFICIENT CAPACITY TO END-HANDLE THE PALLET UNIT.
- P. THE PROCEDURES DEPICTED WITHIN THIS DRAWING ARE BASED ON ENGLISH MEASUREMENTS. THE METRIC EQUIVALENT MAY BE COMPUTED BY USING 1" EQUALS 25.4MM. METRIC EQUIVALENTS FOR WEIGHTS ARE BASED ON 1 POUND EQUALS 0.454KG.
- Q. **NOTICE:** IGLOO MAGAZINES THAT HAVE SINGLE DOORS CANNOT BE USED FOR STORING THIS PALLETIZED MISSILE BECAUSE OF AN INSUFFICIENT DOOR WIDTH. MAGAZINES USED MUST HAVE DOOR OPENINGS THAT ARE WIDER THAN 48 INCHES.

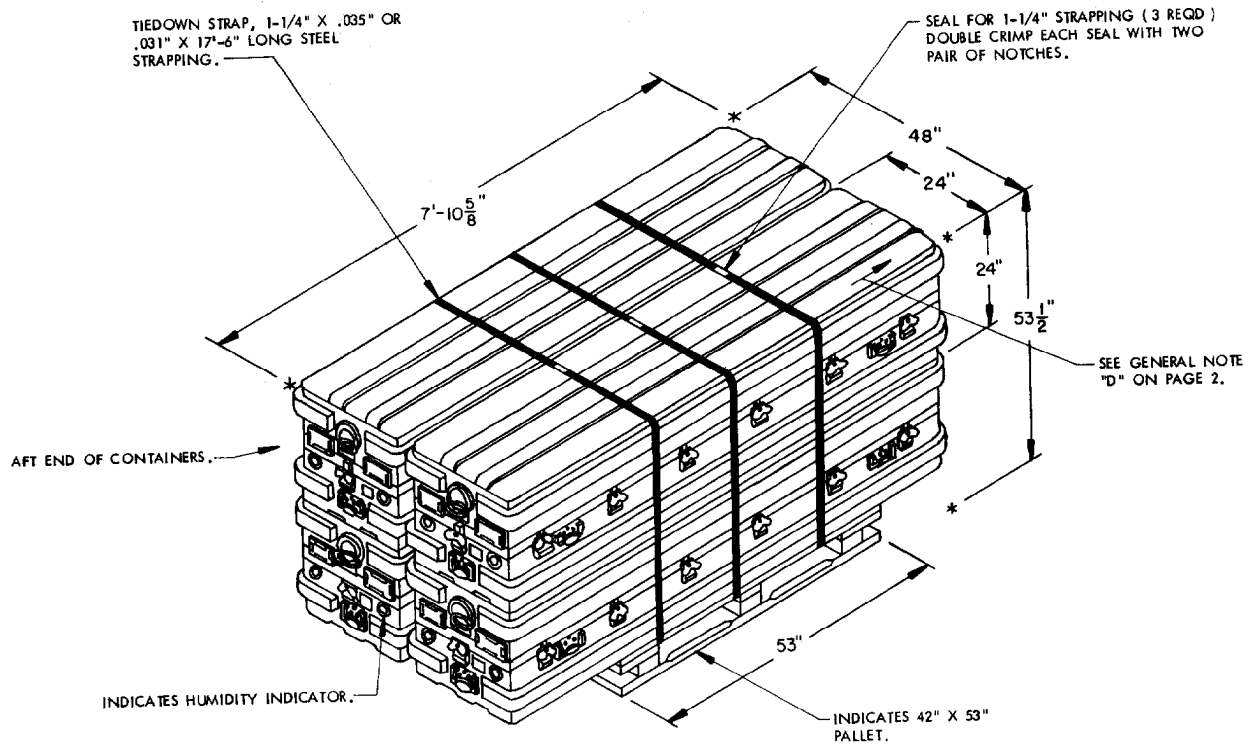

PALLET UNIT

GROSS WEIGHT ----- 1,242 LBS (APPROX)
 CUBE ----- 140.66 CU FT (APPROX)

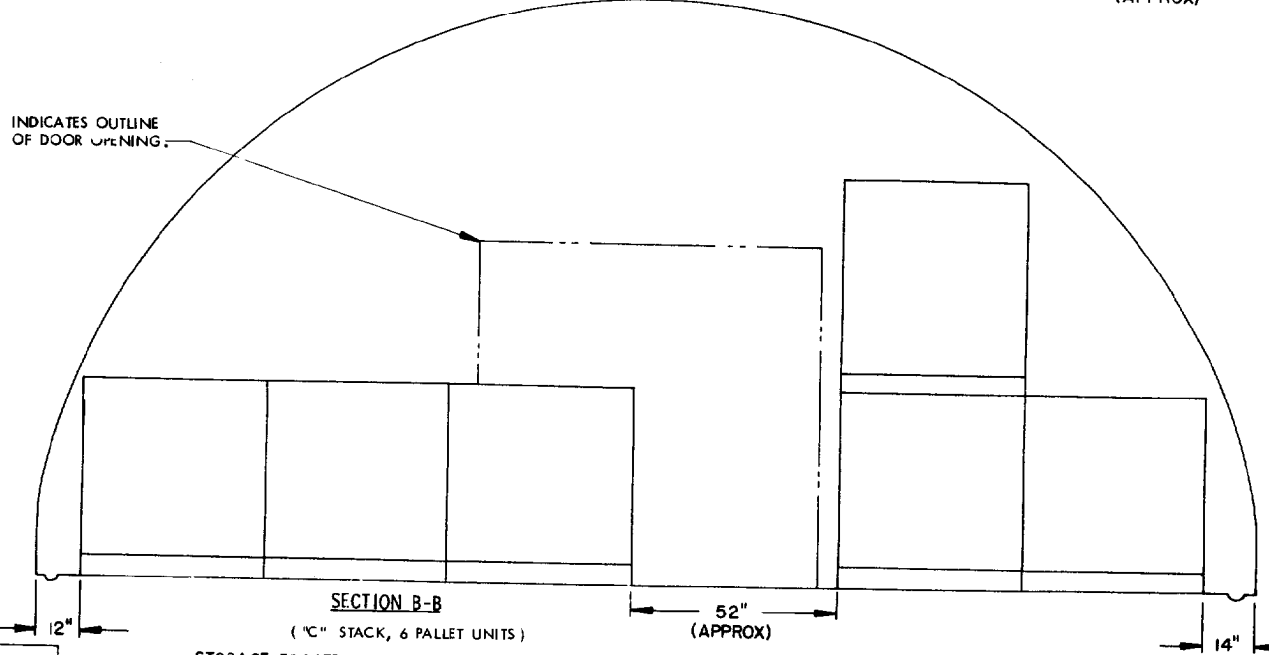
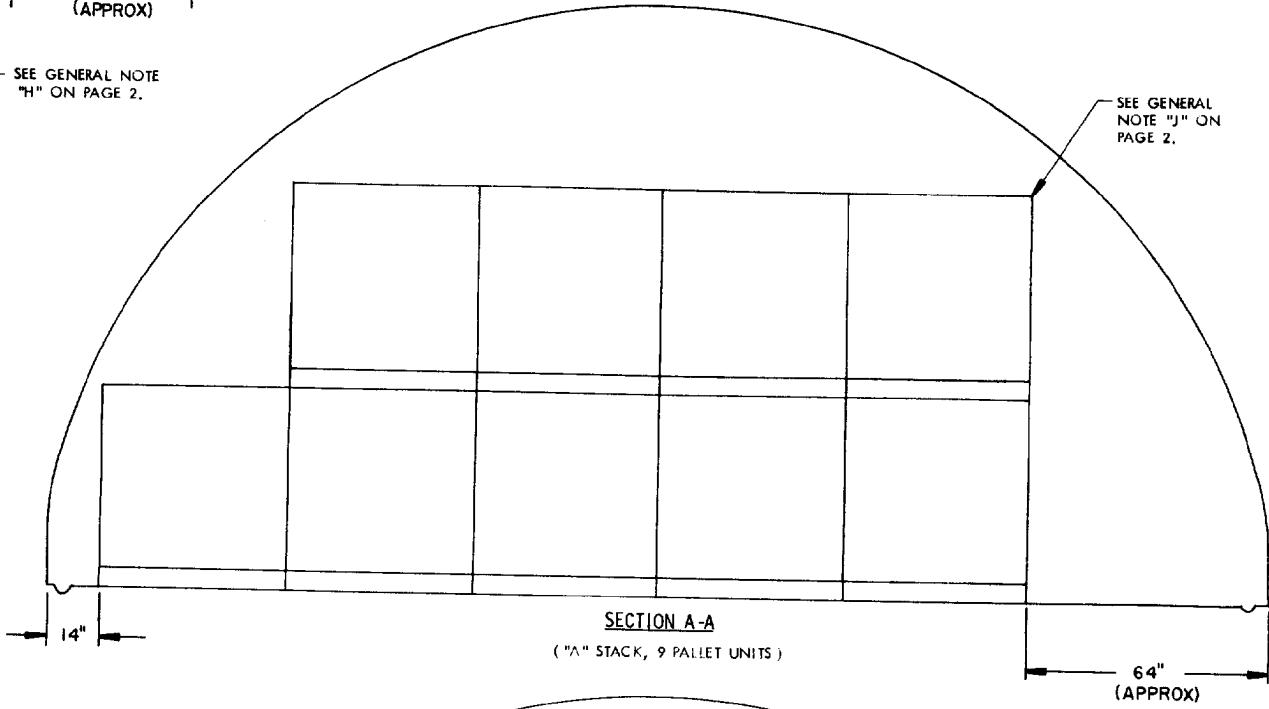
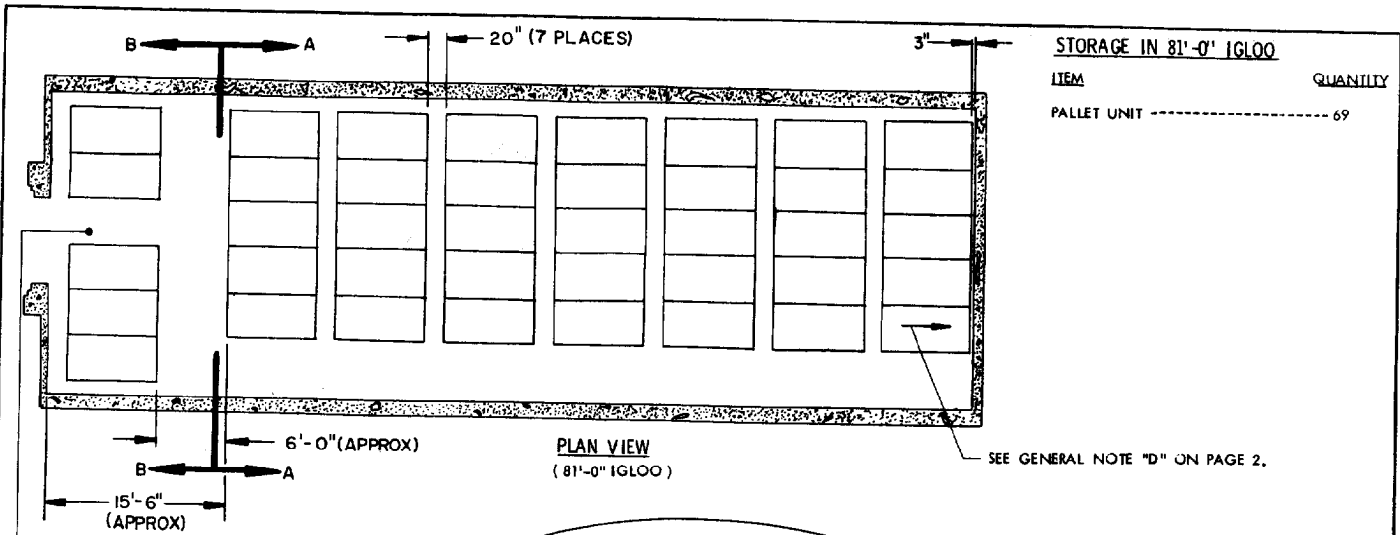

STORAGE IN 60'-8" IGLOO

ITEM _____ QUANTITY _____
PALLET UNIT ----- 51

SEE GENERAL NOTE
"D" ON PAGE 2.

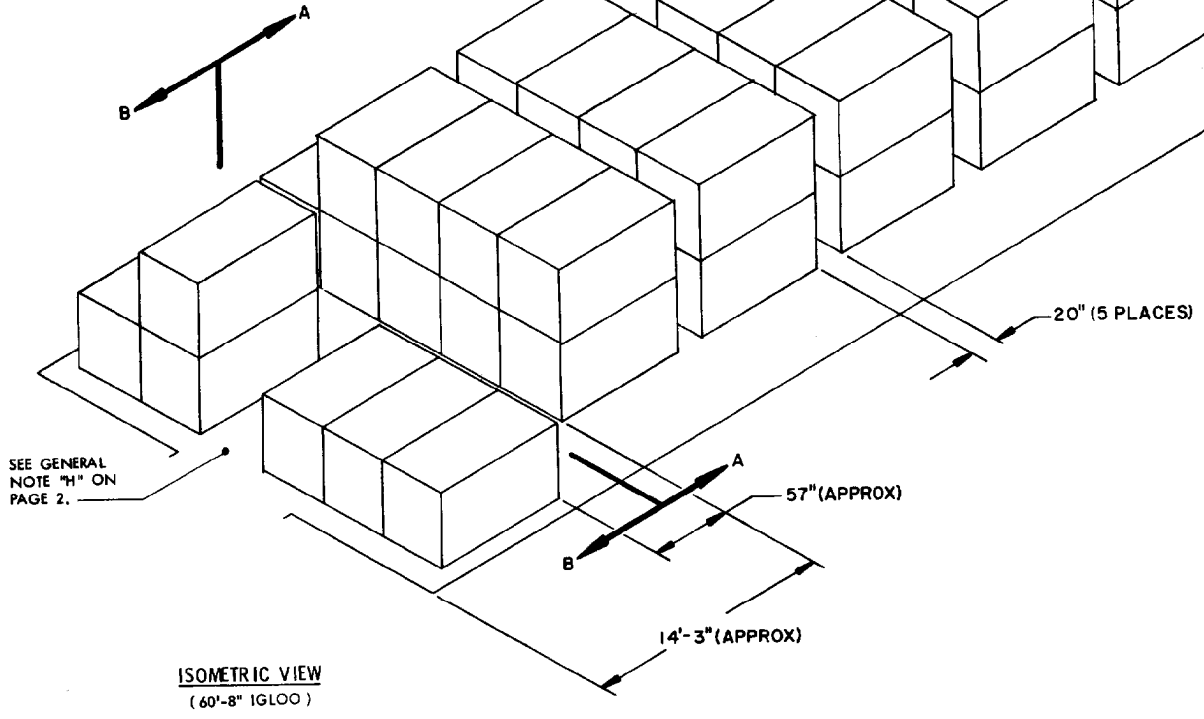

ISOMETRIC VIEW
(60'-8" IGLOO)

FOR "GENERAL NOTES", SEE PAGE 2

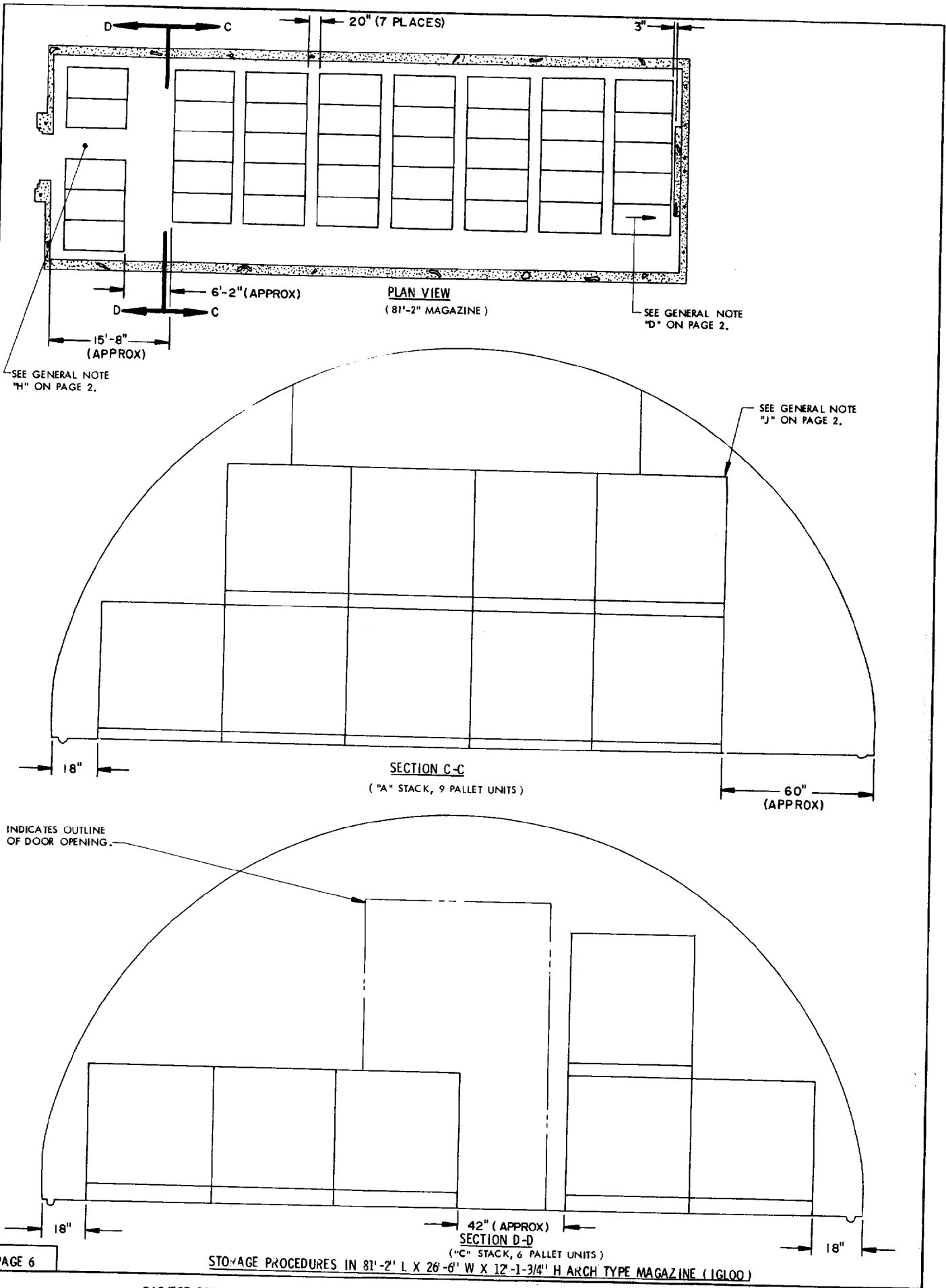

STORAGE IN 81'-2" MAGAZINE

ITEM

QUANTITY

PALLET UNITS ----- 83

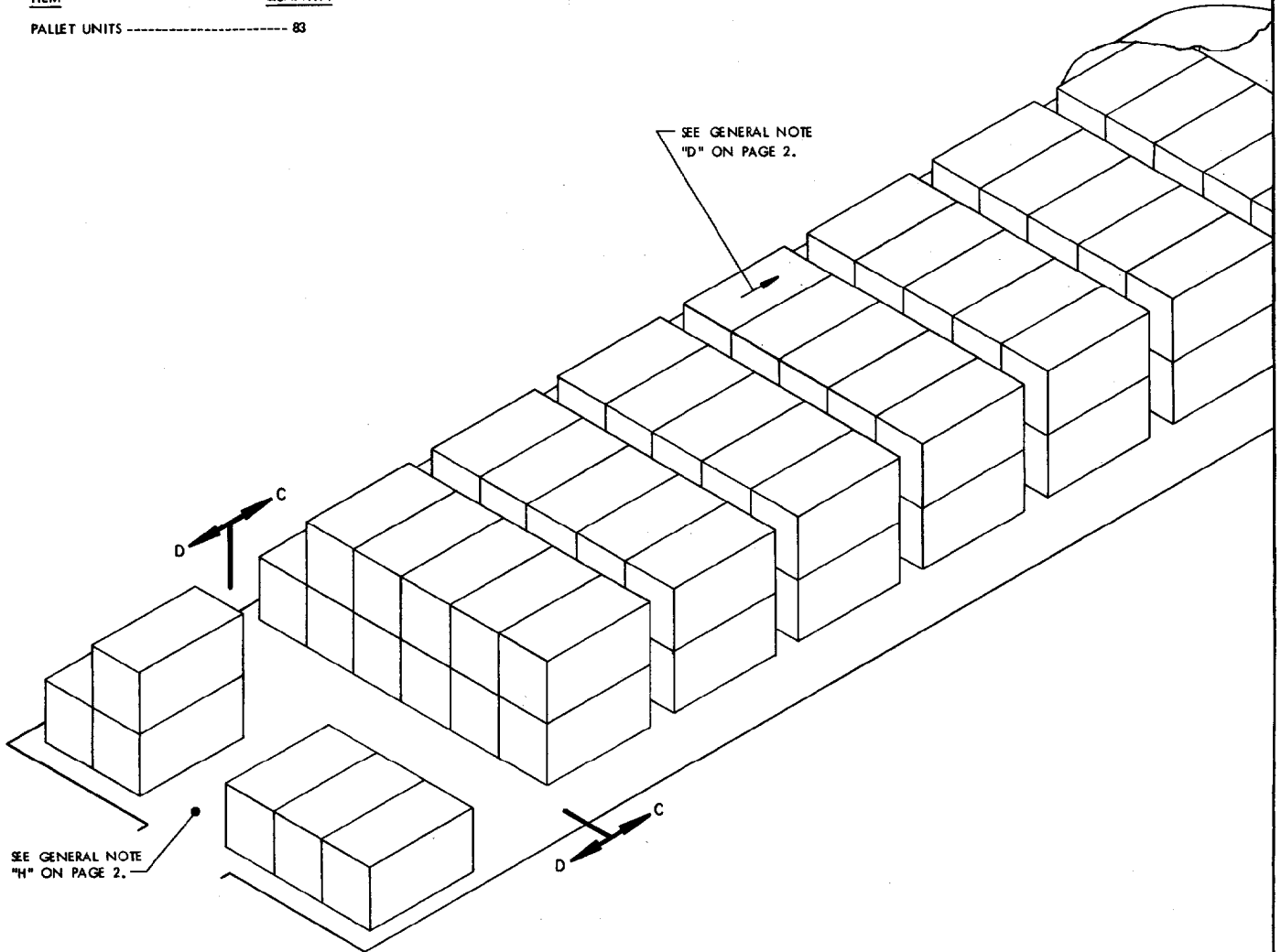

ISOMETRIC VIEW

(81'-2" MAGAZINE)

FOR "GENERAL NOTES", SEE PAGE 2.

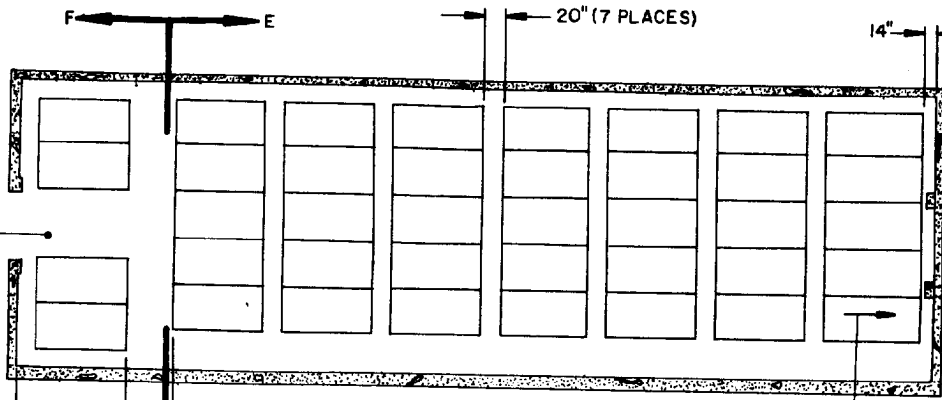

PLAN VIEW
(80'-0" MAGAZINE)

SEE GENERAL NOTE
"D" ON PAGE 2.

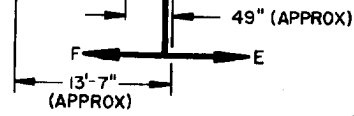

SECTION E-E
("A" STACK, 8 PALLET UNITS)

SEE GENERAL NOTE
"H" ON PAGE 2.

SEE GENERAL NOTE
"J" ON PAGE 2.

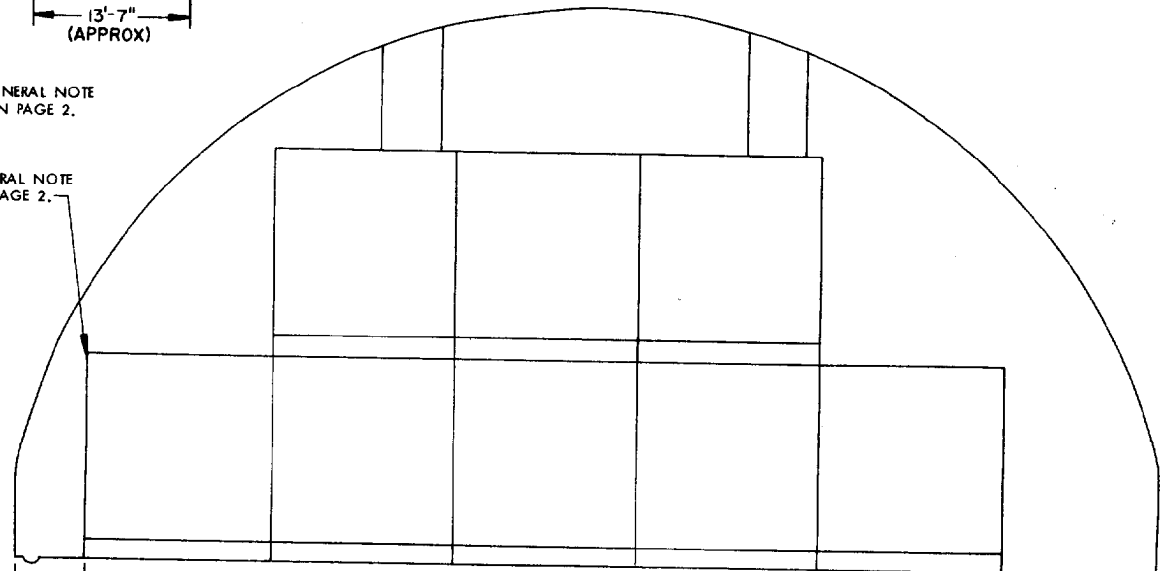

INDICATES OUTLINE OF DOOR OPENING.

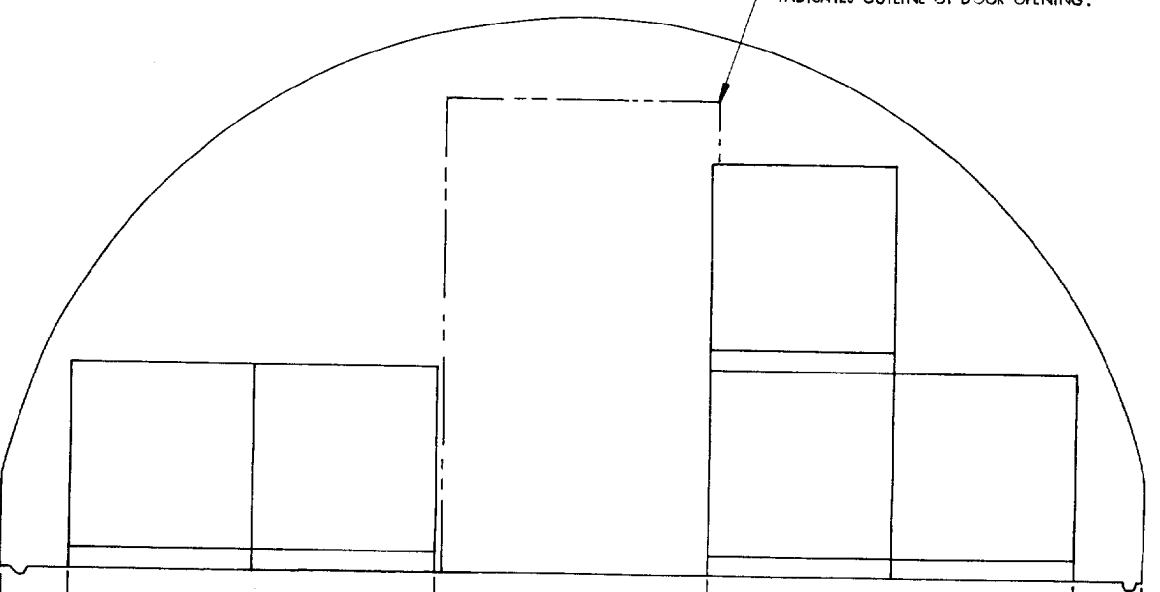

SECTION F-F
("C" STACK, 5 PALLET UNITS)

STORAGE IN 40'-0" MAGAZINE

ITEM _____ QUANTITY _____
 PALLET UNIT ----- 29

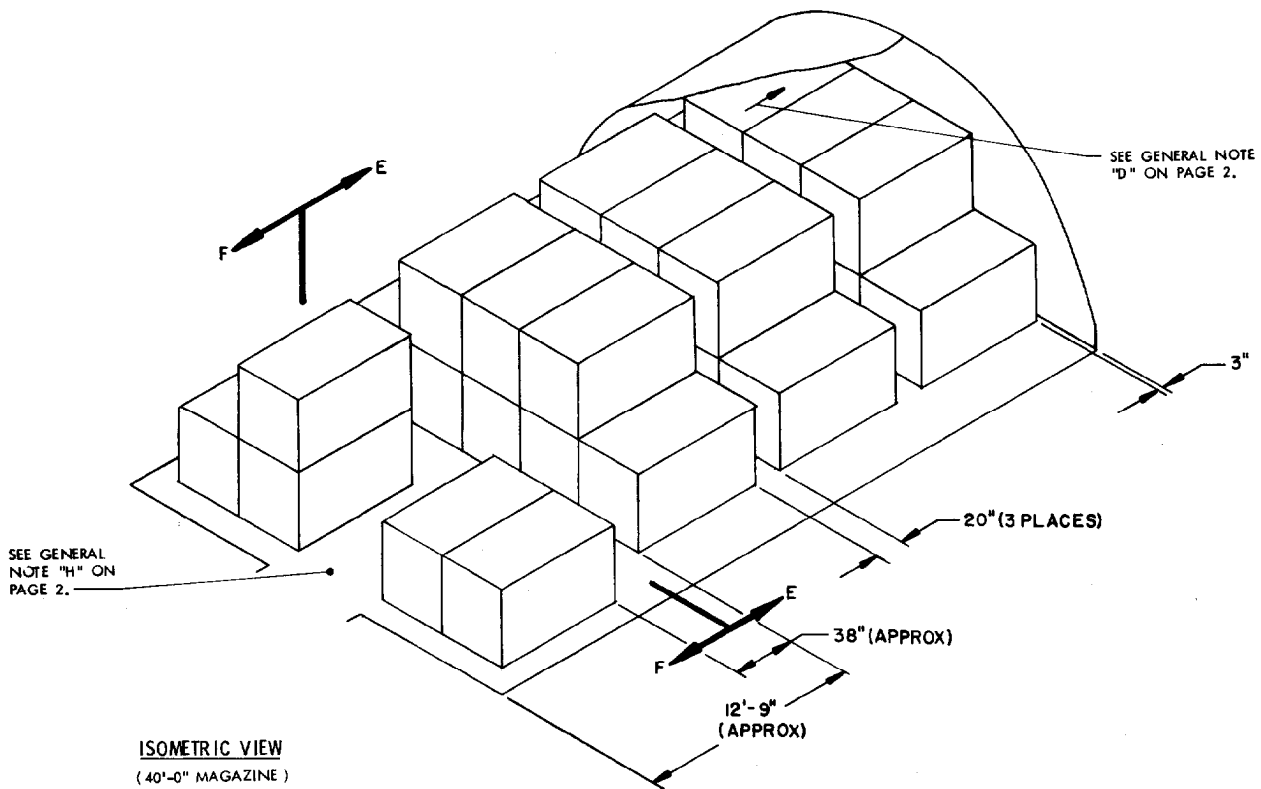

FOR "GENERAL NOTES", SEE PAGE 2.

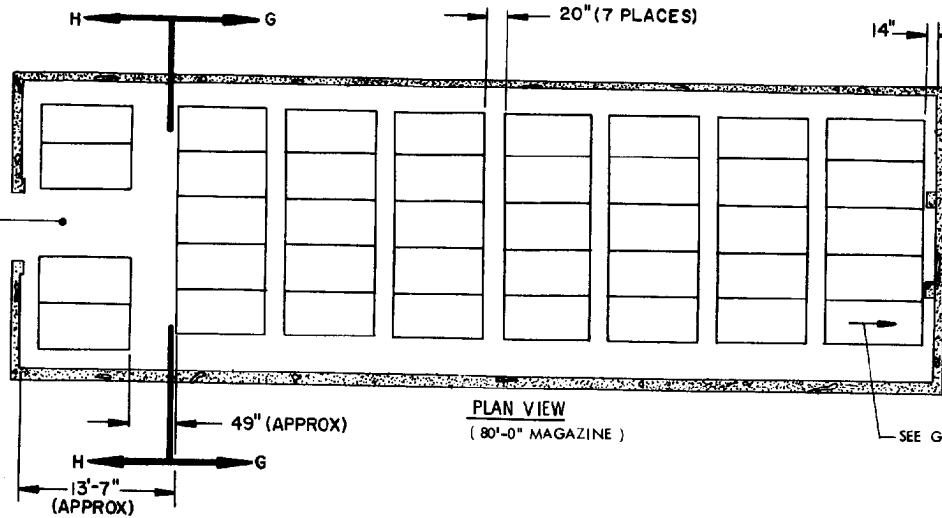

STORAGE IN 80'-0' MAGAZINE	ITEM	QUANTITY
		61

PALLET UNIT ----- 61

SEE GENERAL NOTE "D" ON PAGE 2.

SEE GENERAL NOTE "H" ON PAGE 2.

SEE GENERAL NOTE "J" ON PAGE 2.

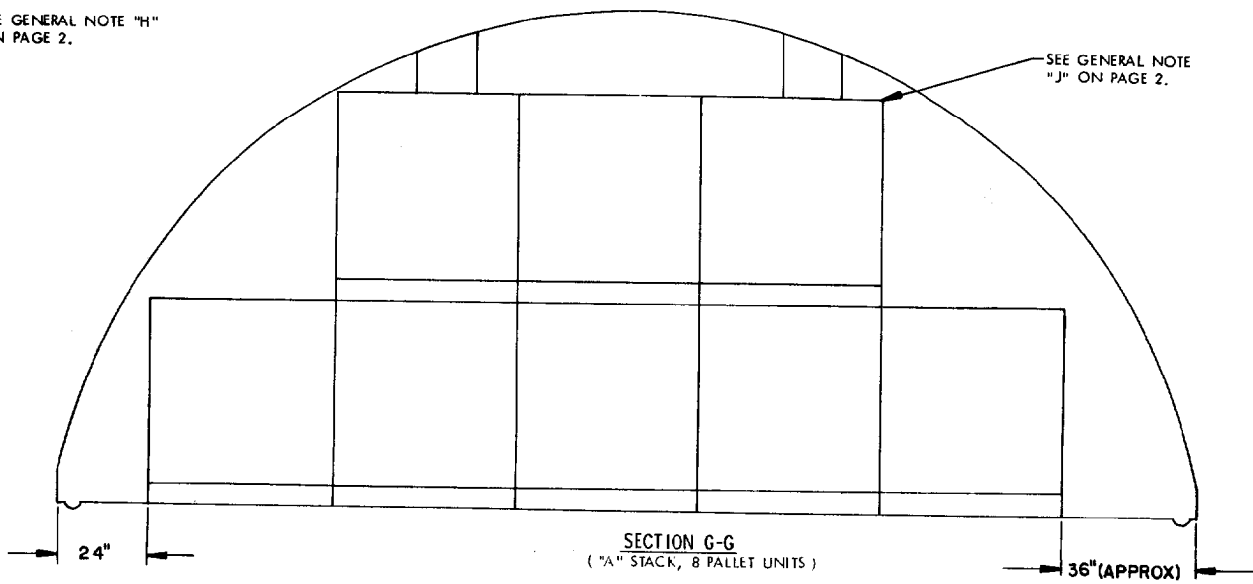

INDICATES OUTLINE OF DOOR OPENING.

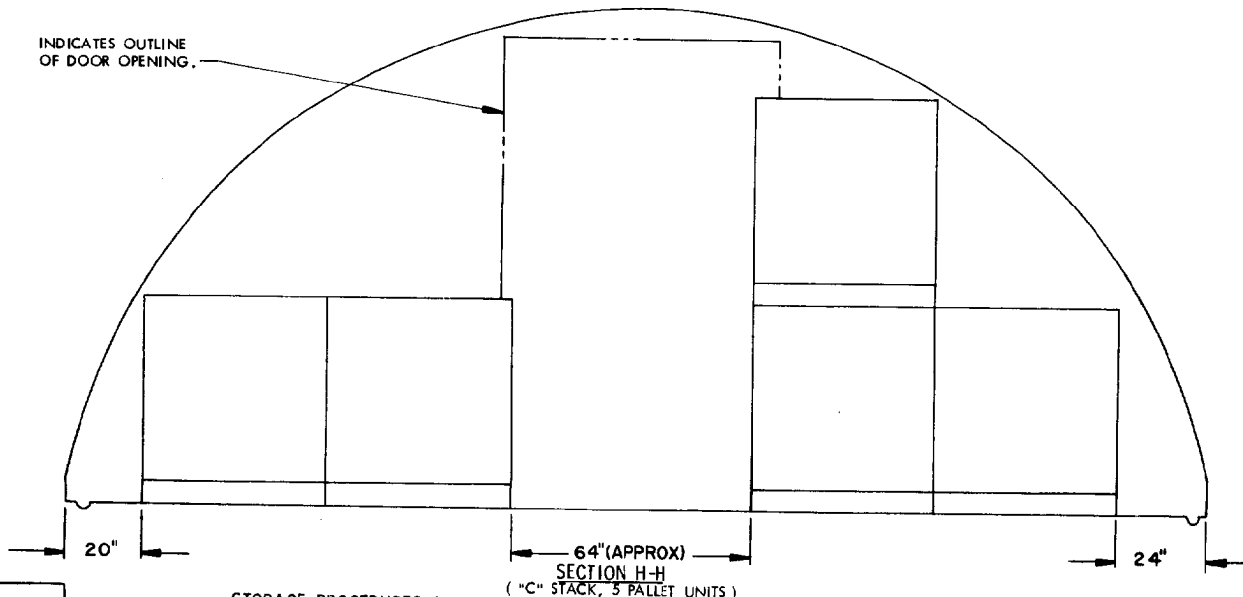

STORAGE IN 40'-0" MAGAZINE

<u>ITEM</u>	<u>QUANTITY</u>
PALLET UNIT -----	29

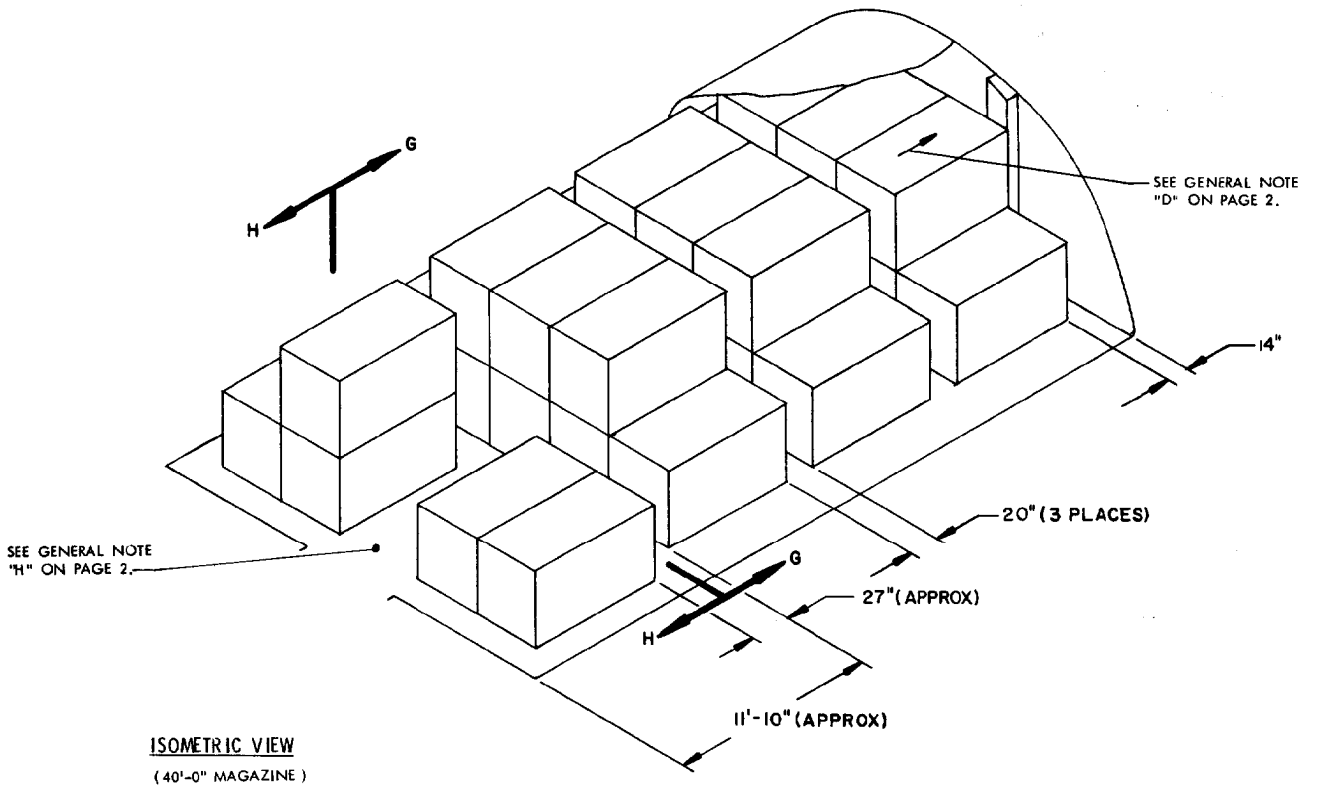

FOR "GENERAL NOTES", SEE PAGE 2.

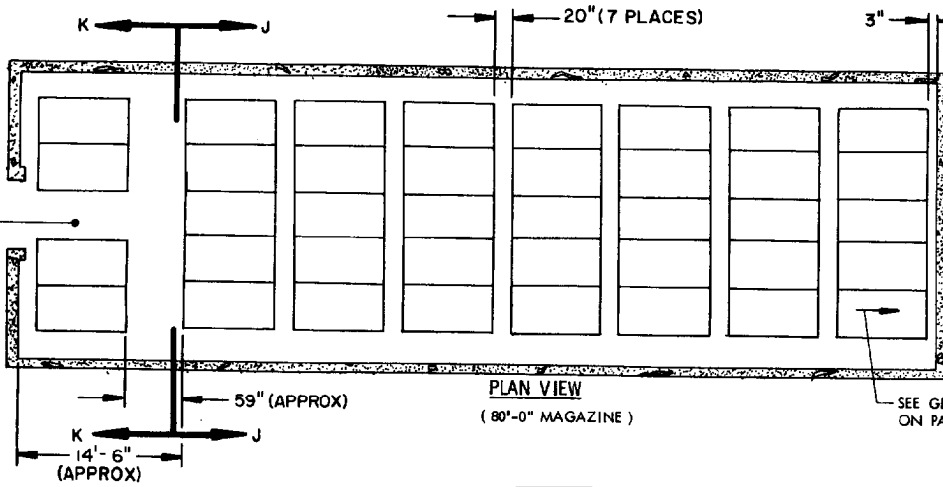

PLAN VIEW
(80'-0" MAGAZINE)

SEE GENERAL NOTE "H" ON PAGE 2.

SEE GENERAL NOTE "D" ON PAGE 2.

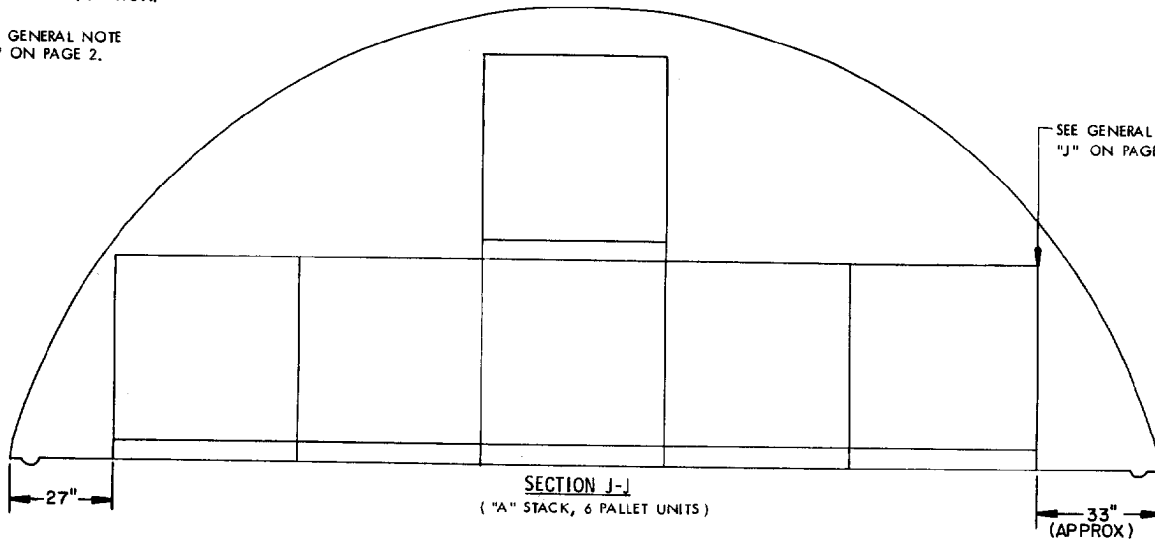

SECTION J-J
("A" STACK, 6 PALLET UNITS)

SEE GENERAL NOTE "J" ON PAGE 2.

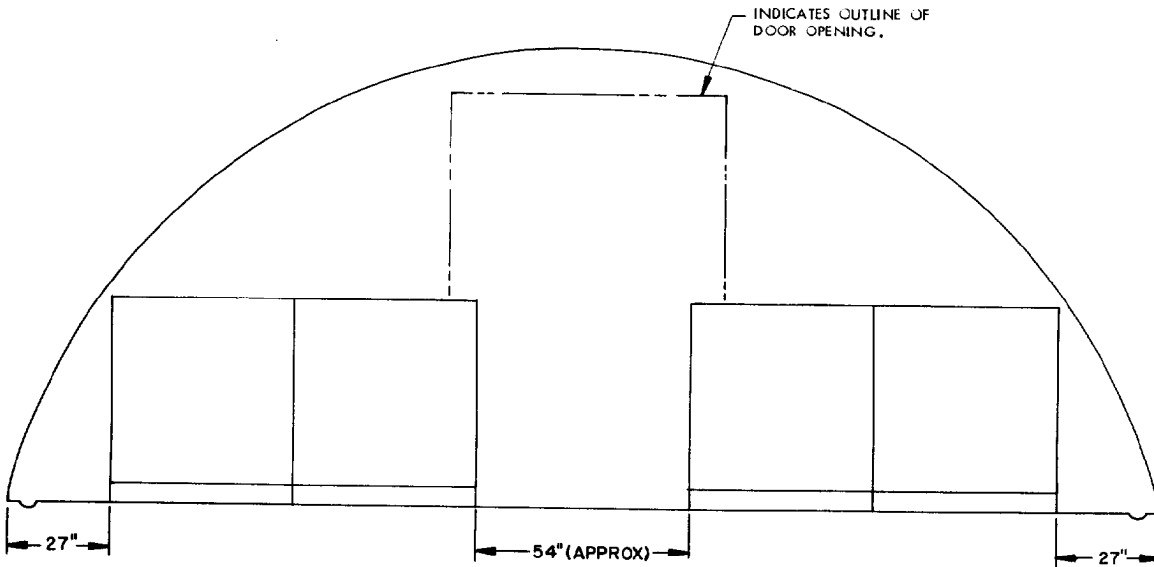

SECTION K-K
("C" STACK, 4 PALLET UNITS)

INDICATES OUTLINE OF DOOR OPENING.

STORAGE IN 40'-0" MAGAZINE

ITEM

QUANTITY

PALLET UNIT ----- 22

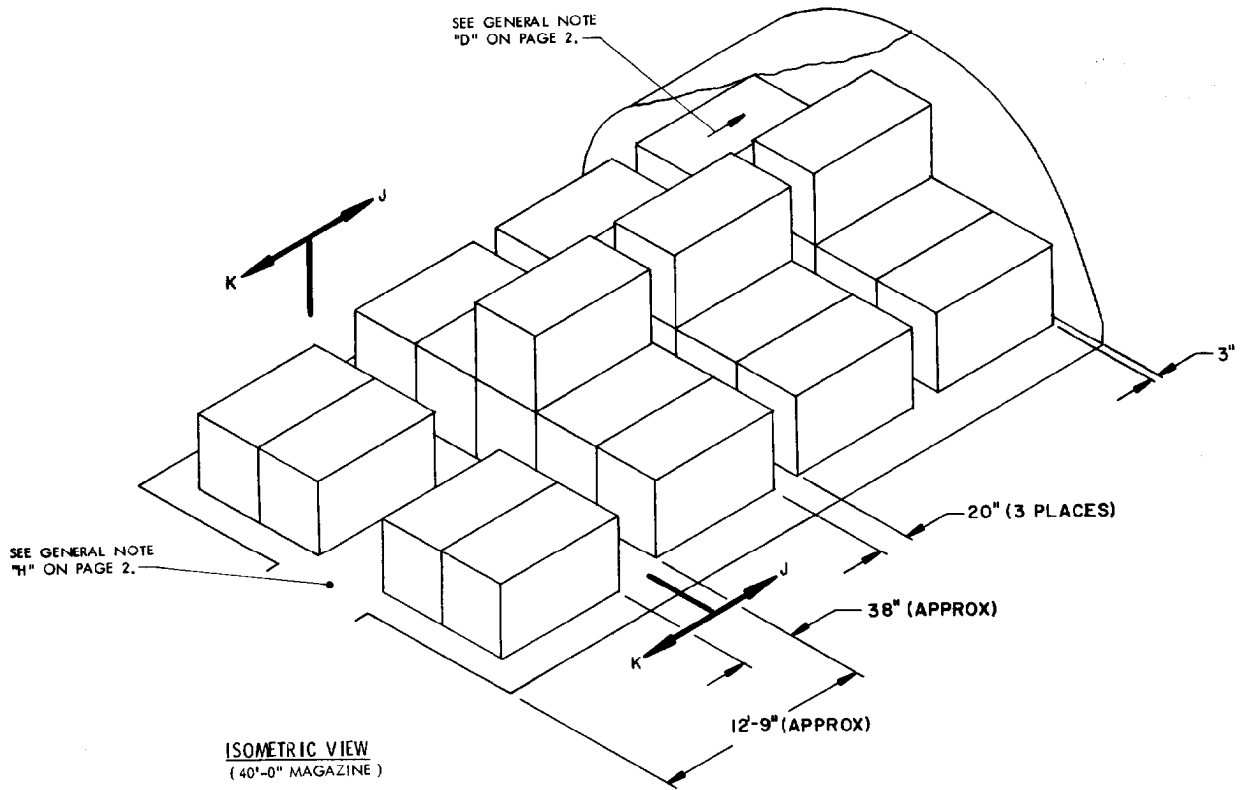

FOR "GENERAL NOTES", SEE PAGE 2.

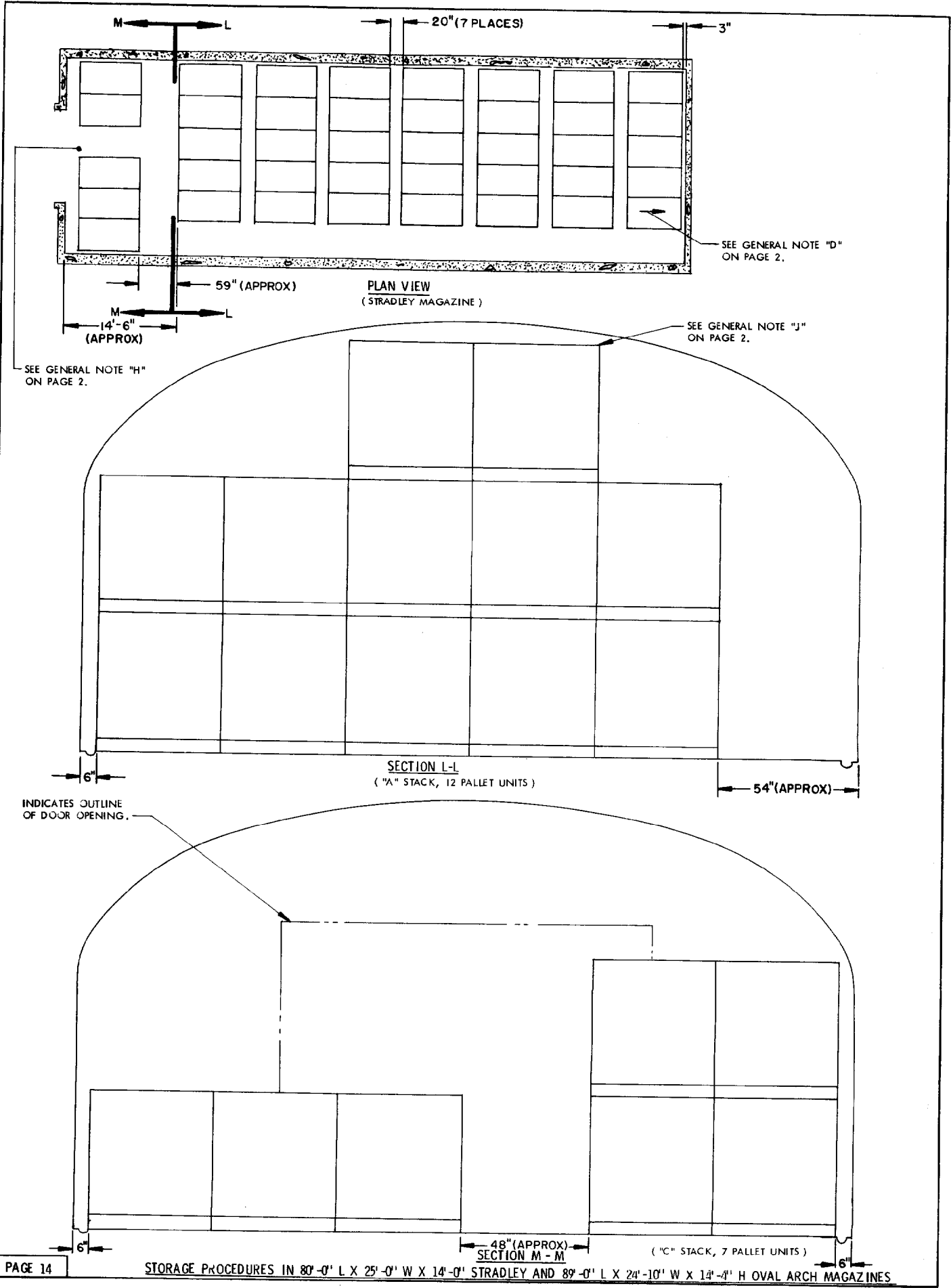

STORAGE IN STRADLEY MAGAZINE

<u>ITEM</u>	<u>QUANTITY</u>
PALLET UNIT -----	91

* STORAGE IN OVAL ARCH MAGAZINE

<u>ITEM</u>	<u>QUANTITY</u>
PALLET UNIT -----	103

- * 8 "A" STACKS
- 1 "C" STACK

SEE GENERAL NOTE "D" ON PAGE 2.

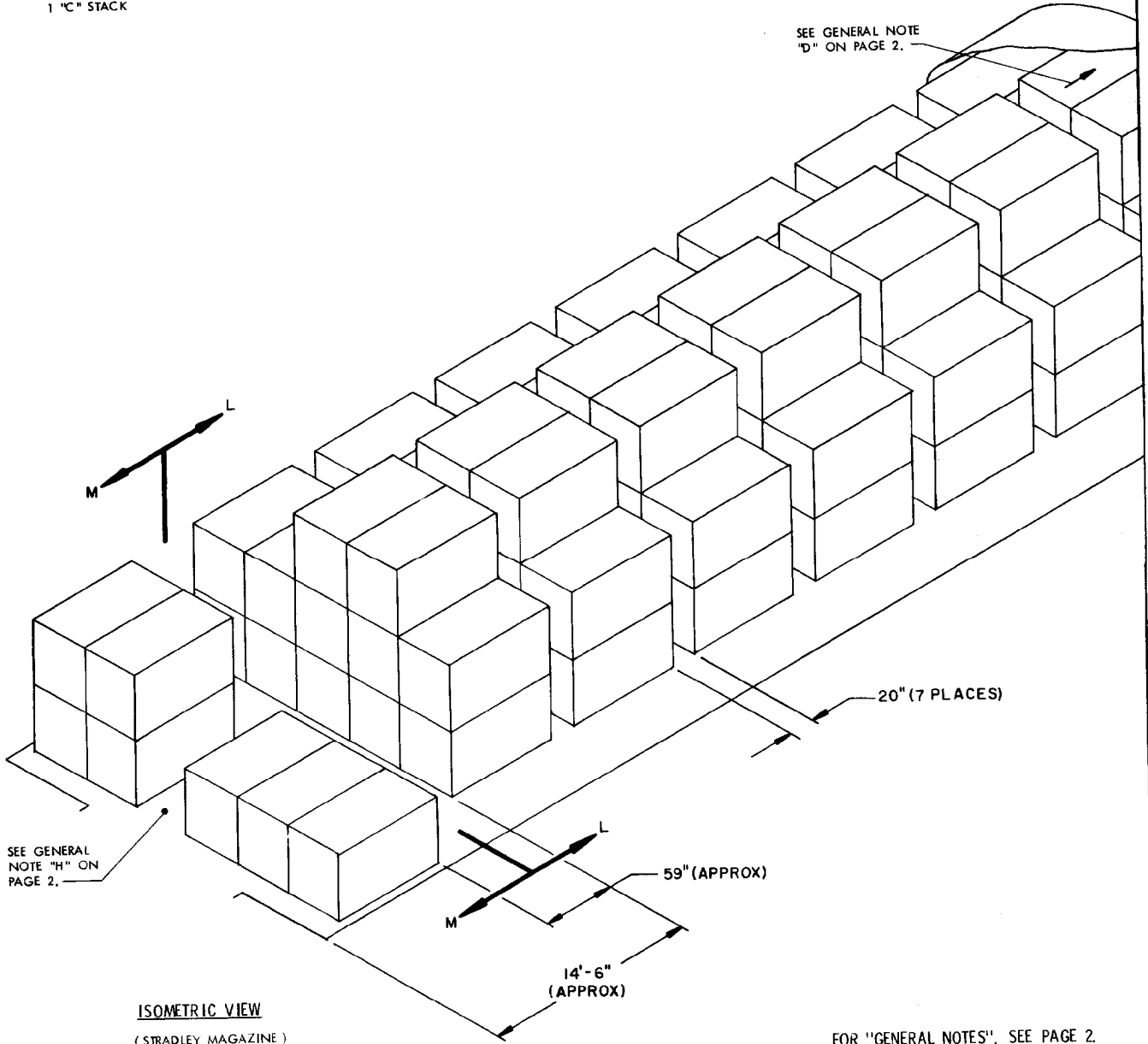

ISOMETRIC VIEW
(STRADLEY MAGAZINE)

FOR "GENERAL NOTES", SEE PAGE 2.

STORAGE IN 44'-7" MAGAZINE

ITEM QUANTITY
 PALLET UNIT----- 46

STORAGE IN 52'-0" MAGAZINE

ITEM QUANTITY
 PALLET UNIT----- 64

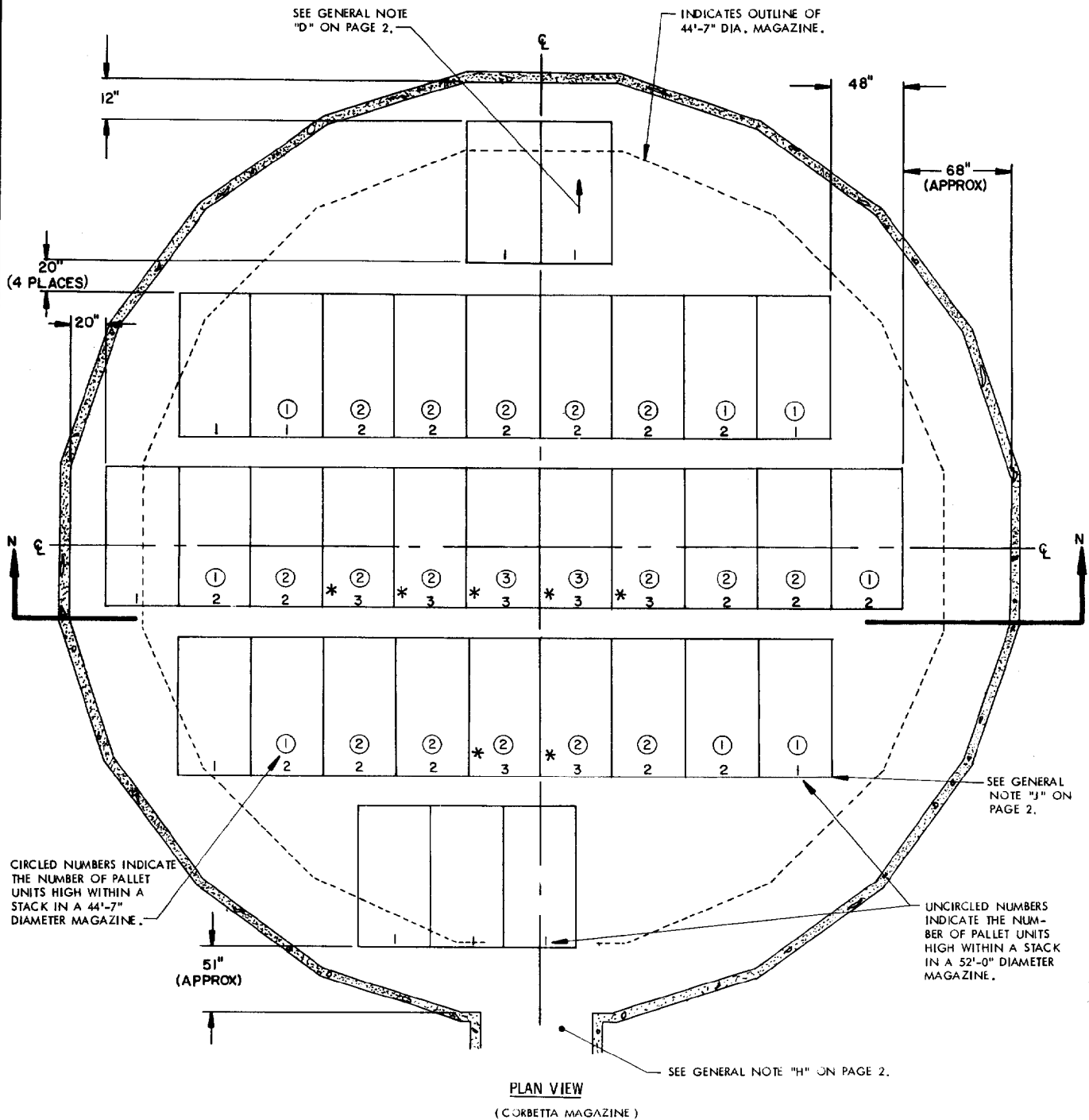

*PALLET UNITS MARKED WITH AN ASTERISK MAY REQUIRE THE HANDLING OF TWO UNITS IN ONE "LIFT" OR MAY HAVE TO BE STORED FROM THE RIGHT SIDE POSITION PRIOR TO PLACEMENT OF THE ADJACENT 1-AND/OR 2-HIGH STACKS.

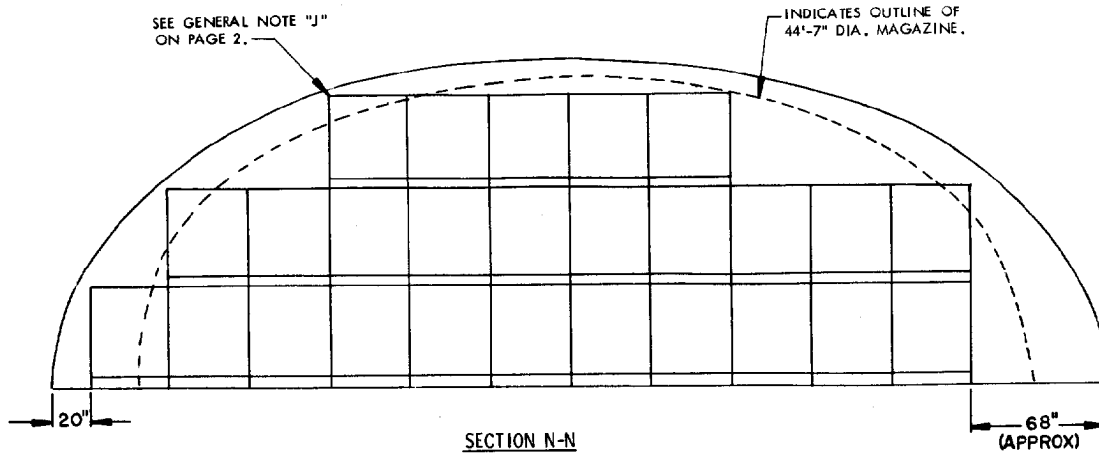

SECTION N-N
 (26 UNITS PER THIS STACK IN A 52'-0"
 DIAMETER MAGAZINE, 20 UNITS PER THIS
 STACK IN A 44'-7" DIAMETER MAGAZINE)

FOR "GENERAL NOTES", SEE PAGE 2

SPECIAL NOTE:

1. THE PRINCIPLES OF STORAGE IN 52'-0" DIAMETER CORBETTA MAGAZINES CAN ALSO BE APPLIED FOR STORAGE IN 44'-7" DIAMETER OR OTHER DIAMETER CORBETTA MAGAZINES. SOME PALLET UNITS MUST BE OMITTED FROM SOME PALLET STACKS TO PROVIDE THE NECESSARY CLEARANCE FROM THE MAGAZINE WALL.

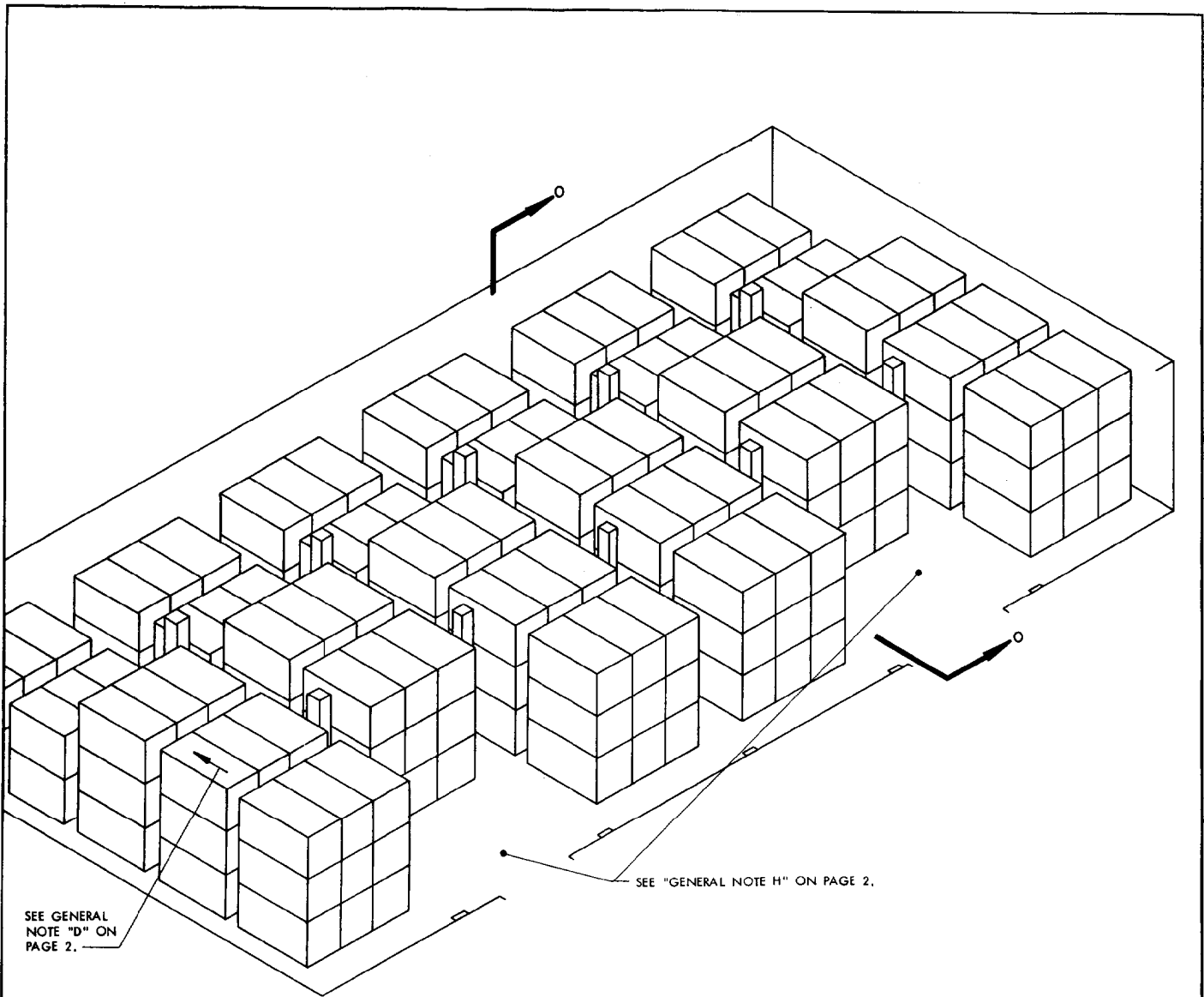

SEE GENERAL
NOTE "D" ON
PAGE 2.

SEE "GENERAL NOTE H" ON PAGE 2.

ISOMETRIC VIEW
(100'-8" L X 50'-0" W MAGAZINE)

FOR "GENERAL NOTES", SEE PAGE 2.

STORAGE IN 100'-8" L X 50'-0" W
RECTANGULAR MAGAZINE

<u>ITEM</u>	<u>QUANTITY</u>
PALLET UNIT -----	72

