

STORAGE IN APPROVED MAGAZINES OF 500-POUND BOMB, MK82 AND MODS, UNITIZED 6 BOMBS PER PALLET UNIT,[●] 40" L X 62" W X 30-1/4" H (NAVY DOMESTIC UNIT, WOOD PALLET)

INDEX

| <u>ITEM</u> | <u>PAGE(S)</u> |
|--|----------------|
| GENERAL NOTES ----- | 2 |
| DETAILS ----- | 3 |
| STORAGE PROCEDURES (EARTH-COVERED MAGAZINES): | |
| 81'-0", 60'-8" AND 40'-4" L X 26'-6" W X 12'-9" H IGLOO MAGAZINES ----- | 4, 5 |
| 81'-2" L X 26'-6" W X 12'-1-3/4" H ARCH TYPE MAGAZINE (IGLOO) ----- | 6 |
| 80'-0" AND 40'-0" L X 25'-0" W X 12'-1-3/4" H ARCH TYPE MAGAZINES (IGLOO) ----- | 7 |
| 80'-0" AND 40'-0" L X 25'-0" W X 11'-0" H ARCH TYPE MAGAZINES (IGLOO) ----- | 8 |
| 80'-0" AND 40'-0" L X 25'-0" W X 10'-0" H ARCH TYPE MAGAZINES (IGLOO) ----- | 9 |
| 80'-0" L X 25'-0" W X 14'-0" H STRADLEY AND 89'-0" L X 24'-10" W X 14'-4" H OVAL ARCH MAGAZINES -- | 10, 11 |
| 52'-0" DIA CORBETTA MAGAZINE ----- | 12, 13 |
| 100'-8" L X 50'-0" W RECTANGULAR MAGAZINE ----- | 14, 15 |
| TYPICAL MULTIPLE-LOT STORAGE PROCEDURES: | |
| IGLOO AND ARCH TYPE MAGAZINES ----- | 16, 17 |
| STRADLEY AND OVAL ARCH TYPE MAGAZINES ----- | 18, 19 |
| CORBETTA MAGAZINE ----- | 20, 21 |
| RECTANGULAR MAGAZINE ----- | 22 |

● SIZE OF UNIT MAY VARY SLIGHTLY, HOWEVER,
PROCEDURES SPECIFIED HEREIN WILL APPLY.

THIS DRAWING SUPERSEDES DRAWING 19-48-4105-
1-14PB1003, DATED MARCH 1974, AS PERTAINS TO
STORAGE PROCEDURES FOR NAVY DOMESTIC UNITS.

DO NOT SCALE

| REVISIONS | | | | DRAWN BY <i>PBS/DAK</i> | PROJ ENG <i>MWD/NEW</i> |
|-----------|--|--|--|--|--|
| | | | | CHECKED <i>GRG/RSH</i> | LOG. ENGINE OFFICE <i>W. J. Emert</i> |
| | | | | APPROVED, U. S. ARMY ARMAMENT MATERIEL READINESS COMMAND | |
| | | | | <i>Lawrence Kuetter</i> | |
| | | | | APPROVED BY ORDER OF COMMANDING GENERAL, U. S. ARMY MATERIEL DEVELOPMENT AND READINESS COMMAND (DARCOM) | |
| | | | | <i>John X. Sigurd W.</i> | |
| | | | | U. S. ARMY DEFENSE AMMUNITION CENTER AND SCHOOL | |
| | | | | U. S. ARMY DARCOM DRAWING | |
| | | | | AUGUST 1979 | |
| | | | | CLASS | DIVISION |
| | | | | 19 | 48 |
| | | | | DRAWING | FILE |
| | | | | 4105/3 | 1-3-4-14 22 PB 1003 |

GENERAL NOTES

- A. THIS DOCUMENT HAS BEEN PREPARED AND ISSUED IN ACCORDANCE WITH AR 740-1, AND AIGMILIT'S IM 743-200-1 (CHAPTER 5).
- B. THE STORAGE PROCEDURES SPECIFIED HEREIN ARE APPLICABLE TO NAVY DOMESTIC UNITS OF 500-POUND MKB2 SERIES BOMBS PACKED 6 PER WOODEN PALLET. FOR DETAILS OF THE UNIT, SEE PAGE 3 AND DRAWING NO. WR-53/702.
 - PALLET UNIT DIMENSIONS ---40" LONG X 62" WIDE X 30-1/4" HIGH (APPROX).
 - GROSS WEIGHT-----3,100 POUNDS (APPROX).
 - CUBE-----43.2 CUBIC FEET.
- C. THE STORAGE PROCEDURES WITHIN THIS DOCUMENT DEPICT STORAGE IN VARIOUS TYPES AND SIZES OF MAGAZINES. THE STORAGE PROCEDURES DEPICTED FOR THE SPECIFIC TYPES OF MAGAZINES MAY ALSO BE UTILIZED TO STORE BOMB PALLET UNITS IN OTHER TYPES OF APPROVED MAGAZINES. MINOR ADJUSTMENTS MAY BE MADE TO FACILITATE STORAGE IN OTHER TYPES OF MAGAZINES, HOWEVER, THE BASIC PRINCIPLES AS DEPICTED HEREIN WILL BE FOLLOWED.
- D. **CAUTION:** THE ALLOWABLE "EXPLOSIVE LIMIT" ESTABLISHED FOR A MAGAZINE IS NOT TO BE EXCEEDED. THIS LIMITATION MAY REQUIRE A QUANTITY REDUCTION FROM THE STORAGE AS SHOWN. SEE GENERAL NOTE "R" BELOW.
- E. STORED PALLET UNITS MUST NOT CONTACT THE WALLS OF A MAGAZINE. TO PROVIDE FOR THIS MANDATORY CLEARANCE REQUIREMENT, UNITS MAY BE ELIMINATED FROM THE DEPICTED STORAGE PATTERN AS NECESSARY.
- F. AISLE DIMENSIONS SHOWN HEREIN MAY BE ADJUSTED TO SUIT LOCAL CONDITIONS AND/OR AVAILABLE MATERIALS HANDLING EQUIPMENT (MHE). HOWEVER, A SIXTEEN INCH (16") (MINIMUM) AISLE IS REQUIRED AT THE NOSE END AND AT THE BASE END OF THE BOMBS TO FACILITATE INSPECTION.
- G. THE STORAGE PROCEDURES AND DIMENSIONS AS SHOWN WITHIN THIS DRAWING ARE BASED ON PALLET UNITS OF BOMBS HAVING FLAT NOSE PLUGS. IF THE BOMBS TO BE STORED HAVE CONICAL NOSE PLUGS, THE NUMBER OF STACKS OR ROWS OF UNITS, AS APPLICABLE, MUST BE REDUCED FROM THAT SHOWN, AS NECESSARY, TO COMPENSATE FOR THE ADDITIONAL SPACE REQUIREMENTS DUE TO THE INCREASED LENGTH OF THE BOMBS WITH CONICAL PLUGS. INSPECTION AISLES, HOWEVER, MUST BE PROVIDED AS SPECIFIED IN NOTE "F" ABOVE.
- H. IF THE AVAILABLE MHE PERMITS, ADDITIONAL PALLET UNITS MAY BE STORED WITHIN THE FRONTAL AREA AND/OR OTHER AVAILABLE AREA OF THE MAGAZINE.
- J. THE HEIGHT OF THE PACKAGE GUARD ON SOME FORKLIFT TRUCKS MAY NOT PERMIT PLACEMENT OF SOME TOP LAYER UNITS IN THE STACKS SHOWN IN THE STORAGE VIEWS HEREIN, UNLESS THE PACKAGE GUARD IS REMOVED (TINE CARRIAGE WILL IN MOST INSTANCES PROVIDE ADEQUATE PACKAGE GUARD PROTECTION).
- K. THE MAXIMUM FLOOR LOAD FOR A MAGAZINE AS PRESCRIBED BY LOCAL STANDARDS WILL NOT BE EXCEEDED.
- L. STACK-STABILIZING DUNNAGE IN THE FORM OF "SHIMS" PROBABLY WILL BE REQUIRED TO ACHIEVE SOUND AND ACCEPTABLE STABLE STACKS. SHIM MATERIAL OF VARYING THICKNESSES WILL BE USED AS REQUIRED TO GAIN LEVEL OR NEARLY LEVEL STACKS AND SOLID BEARING WITHIN A STACK FROM THE FLOOR OF A MAGAZINE TO THE TOP OF THE STACK.
- M. PORTIONS OF THE MAGAZINES, SUCH AS SIDEWALLS, END WALLS, AND ROOFS, HAVE NOT BEEN SHOWN IN THE STORAGE VIEWS FOR CLARITY PURPOSES.
- N. STORAGE OF MULTIPLE LOTS IN A MAGAZINE WILL REQUIRE CAREFUL PREPLANNING SO AS TO INSURE MHE ACCESSIBILITY TO ANY LOT IN ACCORDANCE WITH REQUIREMENTS SET FORTH IN THE APPLICABLE "SPECIAL NOTES" SECTIONS OF THE MULTIPLE-LOT STORAGE PROCEDURES TYPICALLY SHOWN ON PAGES 16 THRU 22.
- O. ALTHOUGH SPECIFIC PROCEDURES ARE INCLUDED IN THIS DRAWING FOR STORING MULTIPLE LOTS WITHIN ONE STRUCTURE, THE BASIC STORAGE PATTERNS AS SHOWN ON PAGES 4 THRU 15 CAN ALSO BE ADAPTED FOR THE STORING OF MORE THAN ONE LOT. LOTS WHEN STORED IN ACCORDANCE WITH A BASIC STORAGE PATTERN MAY BE STORED WITH ONE OR MORE ROWS USED FOR EACH LOT. A SPACE OF APPROXIMATELY 1" WILL HAVE TO BE LEFT BETWEEN ADJACENT ROWS CONTAINING DIFFERENT LOTS UNLESS SEPARATED BY AN INSPECTION/ACCESS AISLE. IN BASIC STORAGE PATTERNS WHERE THE WIDTH OF A ROW IS ESTABLISHED BY THE 62" UNIT-DIMENSION, EACH ROW MAY BE A DIFFERENT LOT AND BE READILY REMOVABLE. IN BASIC STORAGE PATTERNS WHERE THE WIDTH OF A ROW IS ESTABLISHED BY THE 40" UNIT-DIMENSION, A LOT MUST CONSIST OF TWO OR MORE ROWS TO PROVIDE ADEQUATE SPACE TO ACCOMMODATE THE WIDTH OF A FORKLIFT TRUCK FOR STORING OR REMOVING THE LOT. HOWEVER, WHEN THE SIZE OF A LOT REQUIRES THE SPACE OF ONLY ONE 40" WIDE ROW IT MUST BE LOCATED ADJACENT TO AN OTHERWISE REQUIRED ACCESS OR INSPECTION AISLE. THE 1" SPACE BETWEEN LOTS WILL NOT BE EXCEEDED NOR WILL ACCESS AISLES BE PROVIDED SOLELY TO ACCOMMODATE THE WIDTH OF A FORKLIFT TRUCK FOR ONE-ROW STORAGE OF A LOT. FOR ADDITIONAL REQUIREMENTS AND GUIDANCE, SEE THE SPECIAL NOTES FOR MULTIPLE-LOT STORAGE ON PAGES 16 THRU 22.
- P. ANY "LIGHT" PALLETIZED UNIT THAT DOES NOT CONTAIN A FULL QUANTITY OF BOMBS WILL NOT BE BURIED IN STORAGE. IT MUST BE POSITIONED ADJACENT TO AN AISLE, PREFERABLY IN FRONT OF THE LOT.
- Q. BOMBS PRESENTLY STORED IN ACCORDANCE WITH A PRIOR APPROVED DRAWING NEED NOT BE RE-STORED SOLELY TO CONFORM TO THE PROCEDURES SPECIFIED IN THIS DOCUMENT.
- R. IF THE QUANTITY OF UNITS FOR A MAGAZINE IS TO BE REDUCED FROM WHAT IS SHOWN HEREIN - DUE TO THE PERMITTED "EXPLOSIVE LIMIT" OR FOR ANY OTHER REASON, SUCH AS A LIMITED QUANTITY TO BE STORED - THE DELINEATED PROCEDURES ARE TO BE ADJUSTED BY OMITTING STACKS RATHER THAN BY OMITTING LAYERS.
- S. THE POSITIONING OF THE NOSE-END OF BOMBS WITHIN A MAGAZINE IS INDICATED BY ARROWS IN THE STORAGE VIEWS. FOR STORAGE PROCEDURES SHOWN ON PAGES 4 THRU 15, THE POSITIONING OF THE NOSE-END OF BOMBS IS INDICATED ONLY TO FACILITATE STORAGE OPERATIONS AND PROVIDE FOR A UNIFORM AND ORDERLY STORAGE PATTERN AND, THEREFORE, IS NOT A MANDATORY REQUIREMENT. HOWEVER, FOR STORAGE OF MULTIPLE LOTS, AS TYPICALLY SHOWN ON PAGES 16 THRU 19, THE NOSE-END DIRECTIONS AS SHOWN GENERALLY MUST BE COMPLIED WITH TO PERMIT BASE-END HANDLING OF UNITS FOR REMOVAL FROM STORAGE WITHOUT THE NECESSITY FOR HANDLING AND RELOCATING ADJACENT LOTS.

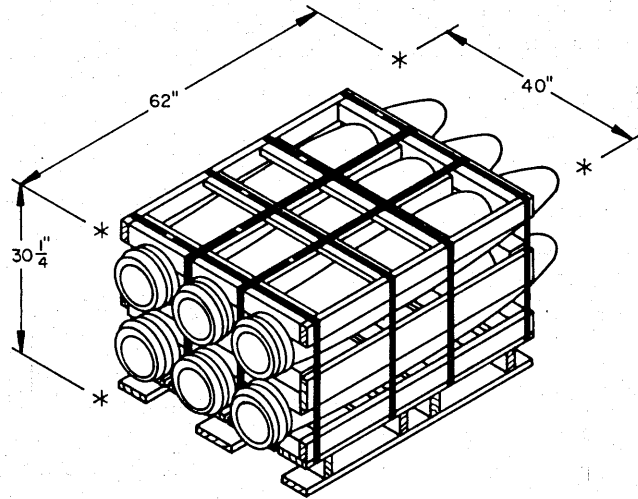

PALLET UNIT

NAVY DOMESTIC UNIT,
6 BOMBS PER WOODEN PALLET,
UNIT WEIGHT ----- 3,100 LBS. (APPROX)
CUBE ----- 43.2 CUBIC FEET

SEE GENERAL NOTE "G" ON PAGE 2.

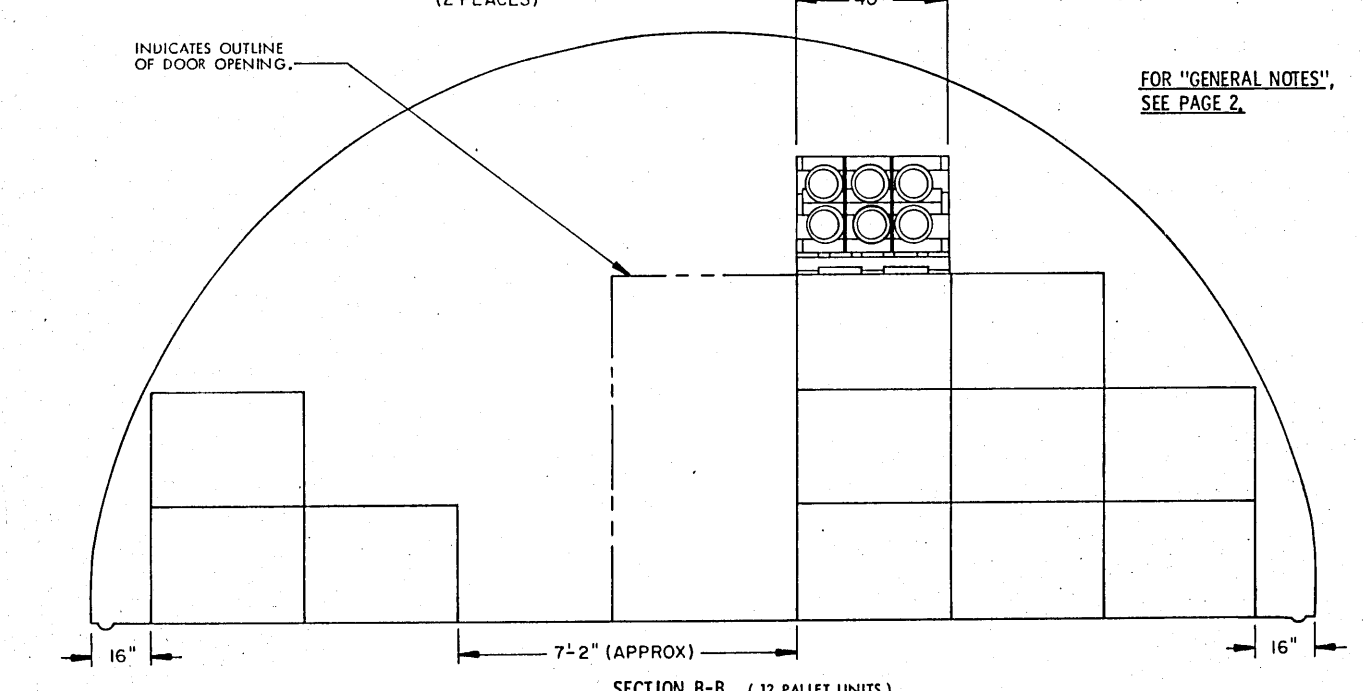
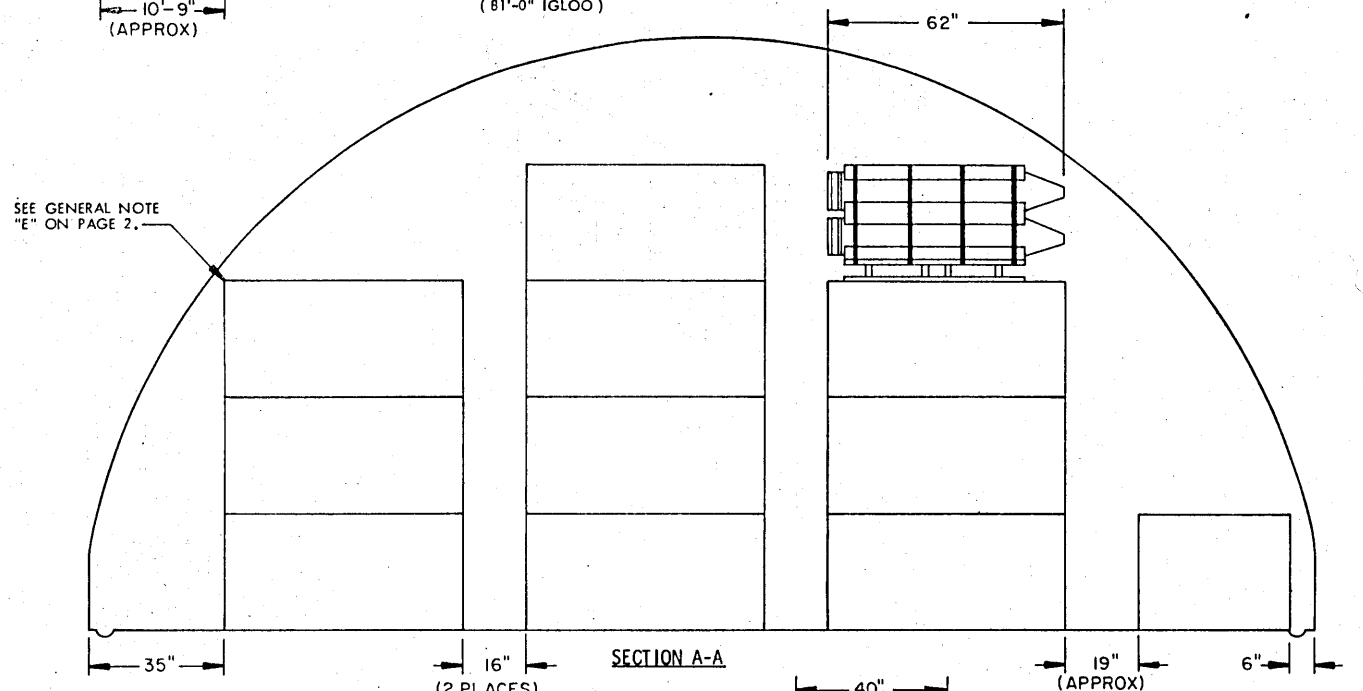
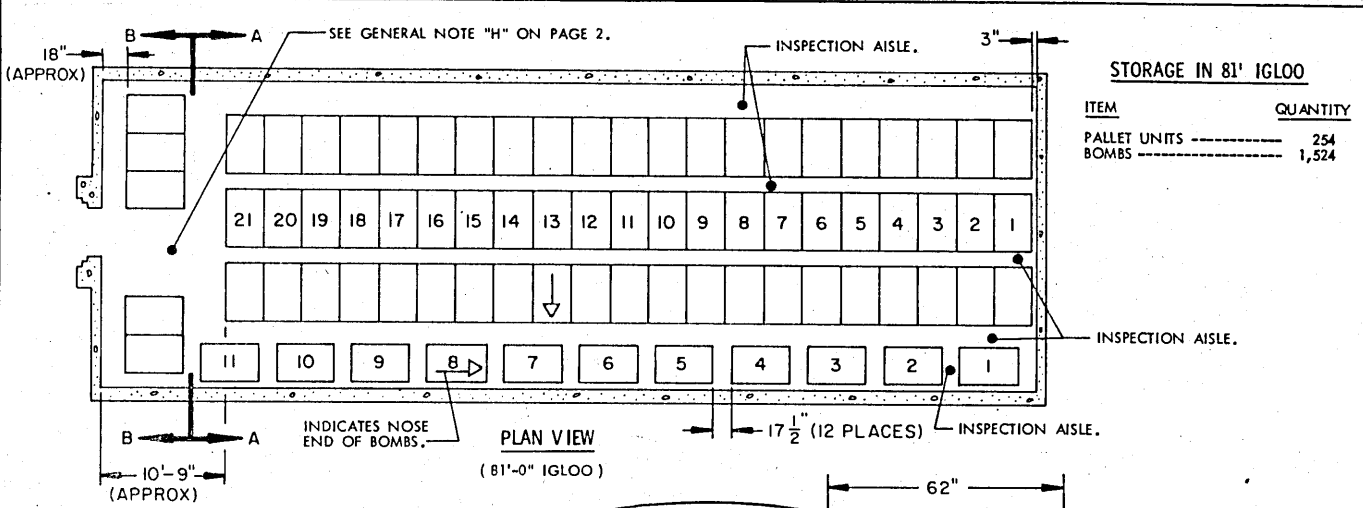

STORAGE IN 60' IGLOO

(12'-9" HIGH)

| ITEM | QUANTITY |
|--------------------|----------|
| PALLET UNITS ----- | 185 |
| BOMBS ----- | 1,110 |

***STORAGE IN 40' IGLOO**

(12'-9" HIGH)

| ITEM | QUANTITY |
|--------------------|----------|
| PALLET UNITS ----- | 105 |
| BOMBS ----- | 630 |

- * 8 LATERAL (11-UNIT) STACKS-- 88
- 5 LONGITUDINAL (1-UNIT) STACKS 5
- 1 FRONTAL STACK----- 12
- 16" INSPECTION AISLES.

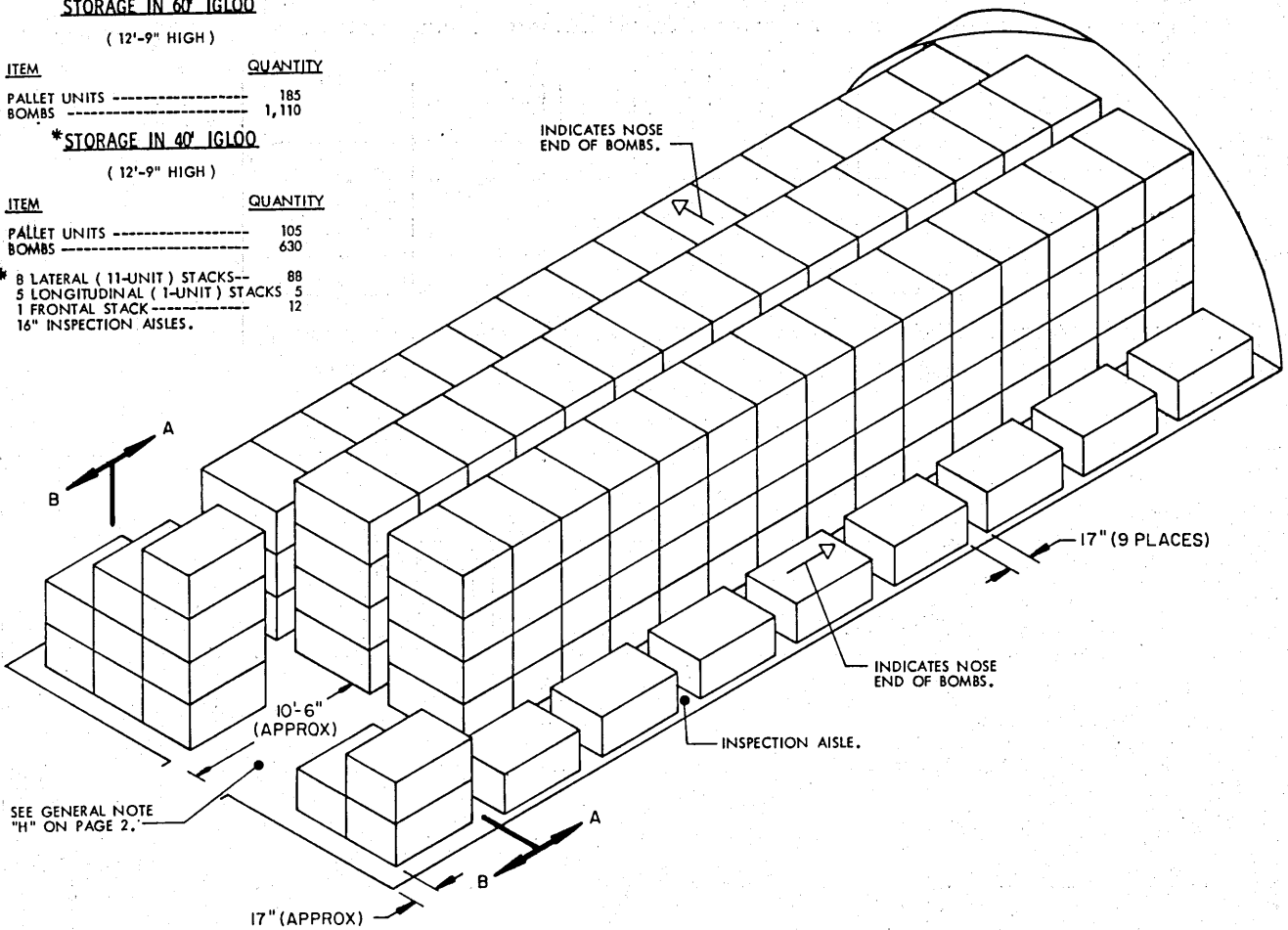

ISOMETRIC VIEW

(60'-8" IGLOO)

FOR "GENERAL NOTES", SEE PAGE 2.

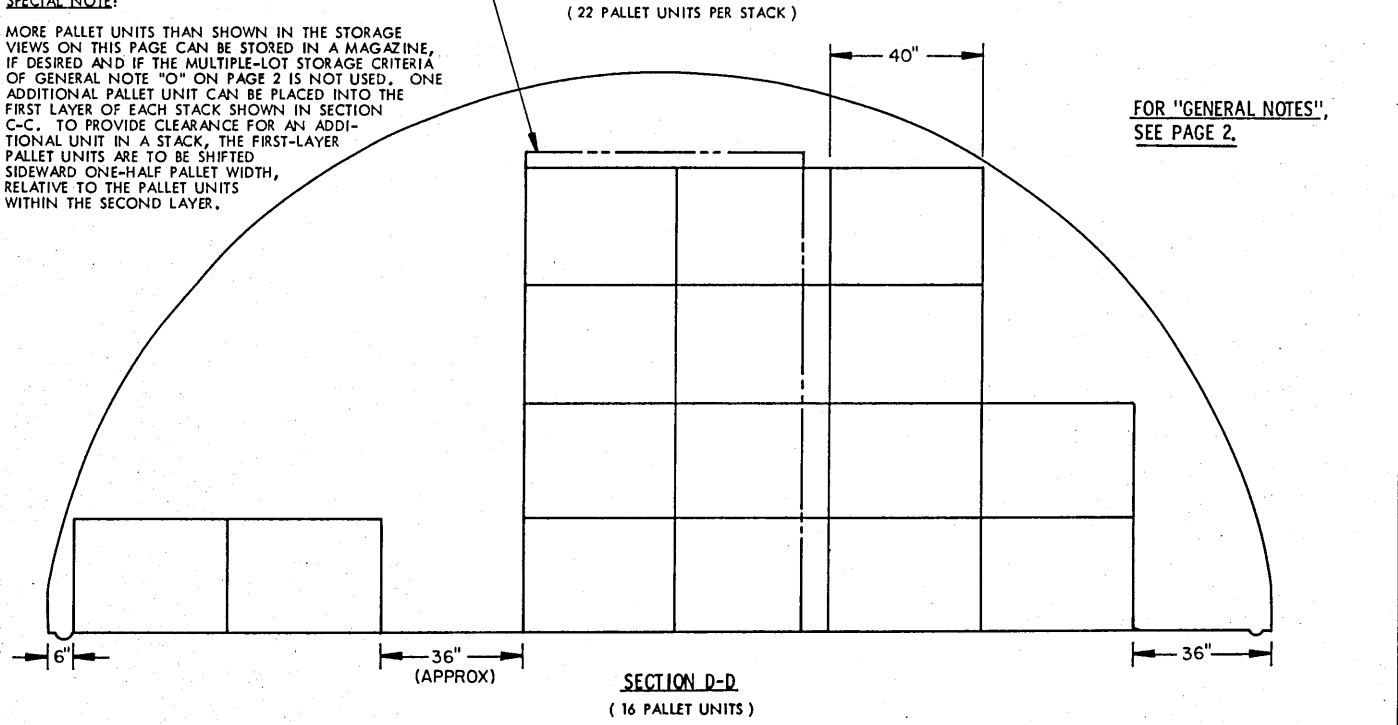
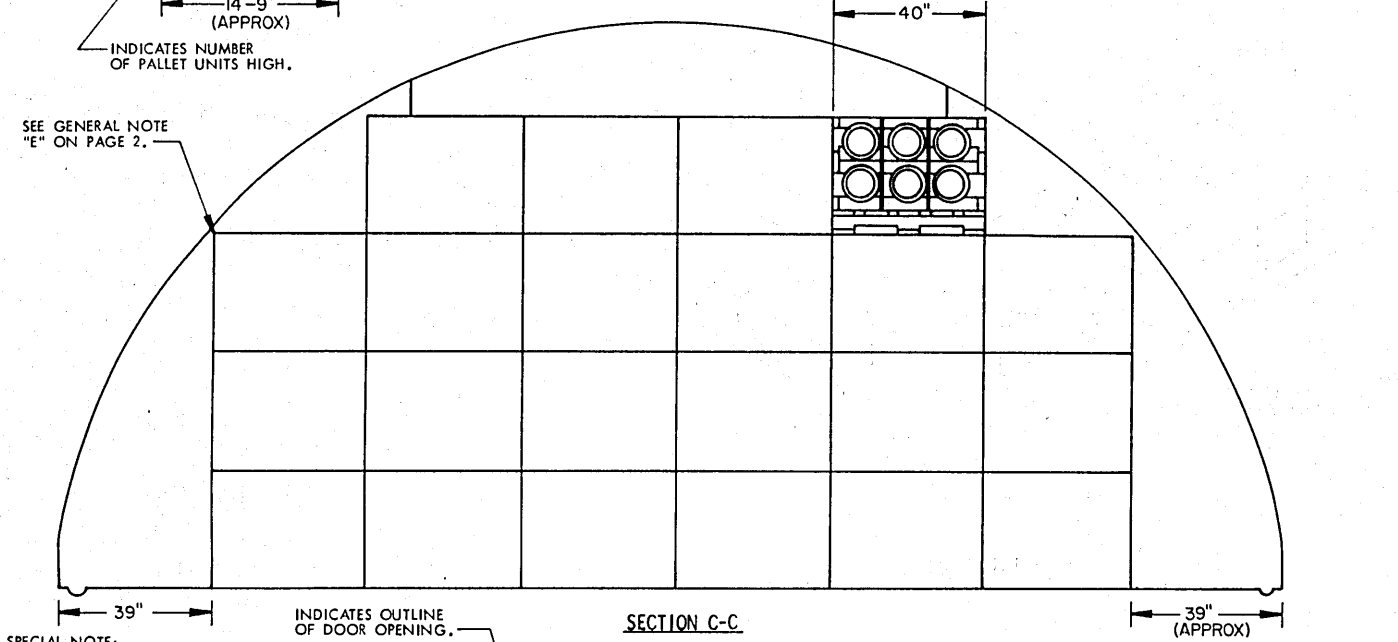
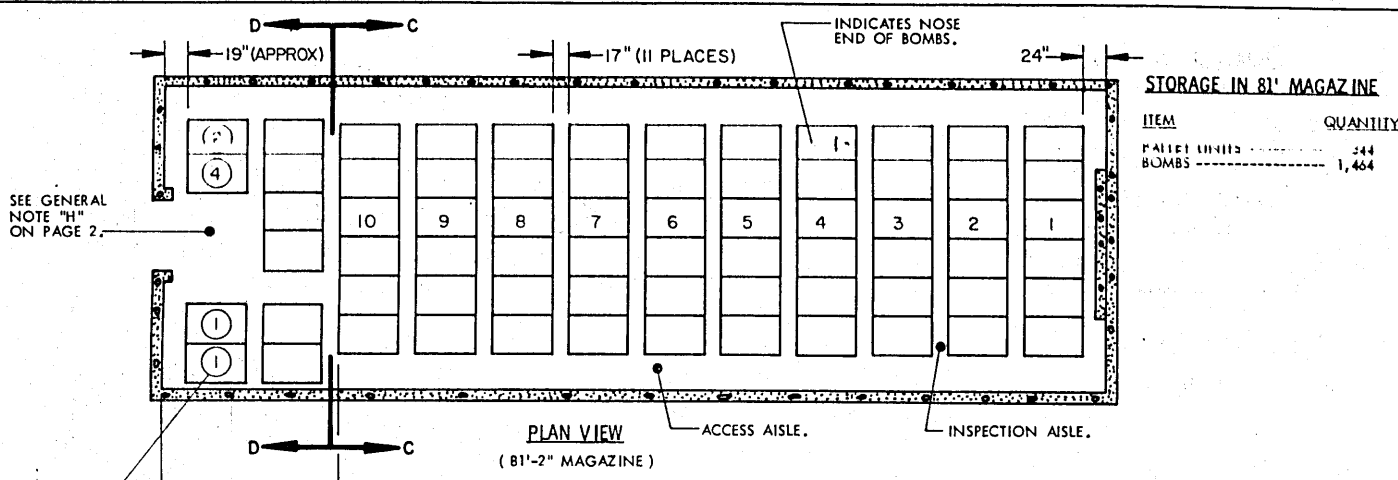

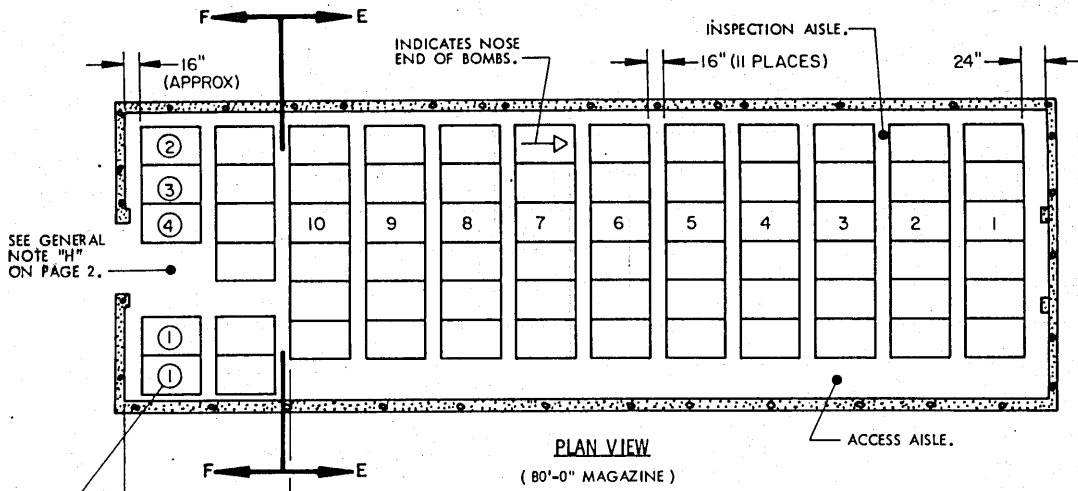

STORAGE IN 80' MAGAZINE
(12' HIGH)

| ITEM | QUANTITY |
|--------------|----------|
| PALLET UNITS | 226 |
| BOMBS | 1,356 |

*** STORAGE IN 40' MAGAZINE**
(12' HIGH)

| ITEM | QUANTITY |
|----------------------|----------|
| PALLET UNITS | 91 |
| BOMBS | 546 |
| * 4 (20-UNIT) STACKS | 80 |
| 1 FRONTAL STACK | 11 |

24" INSPECTION AISLES.

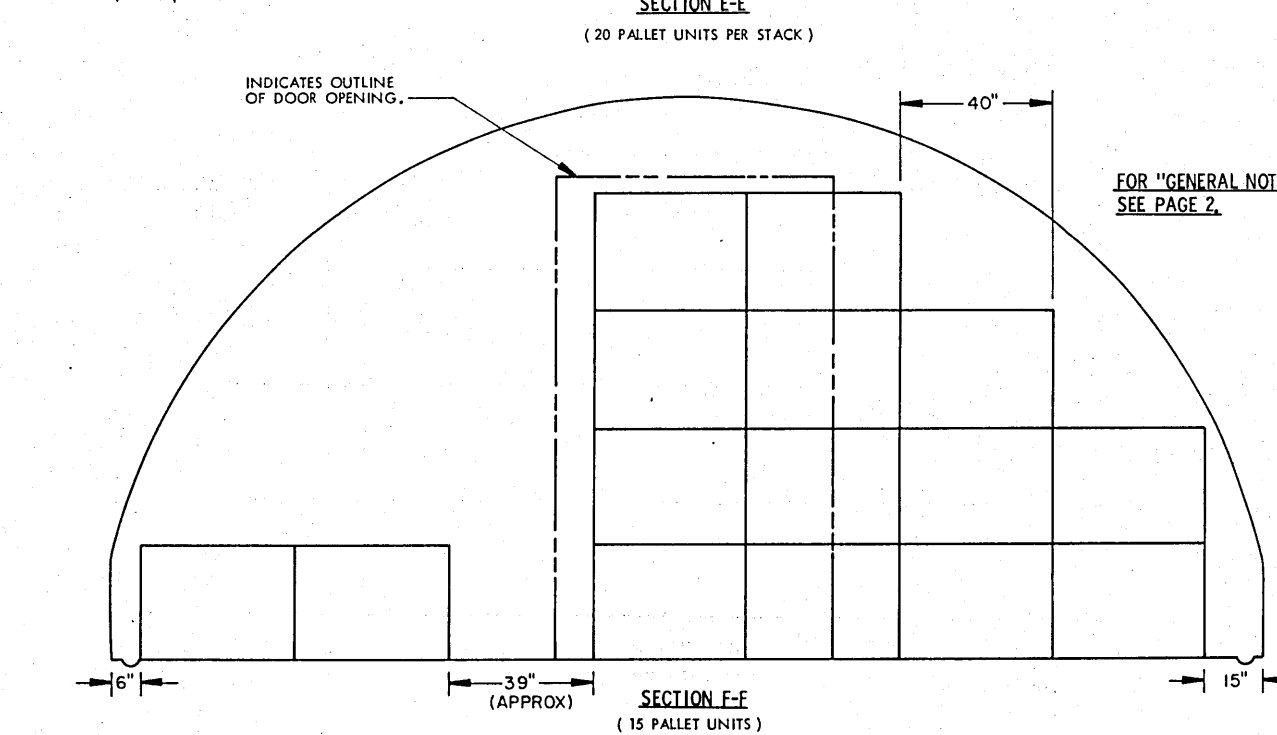
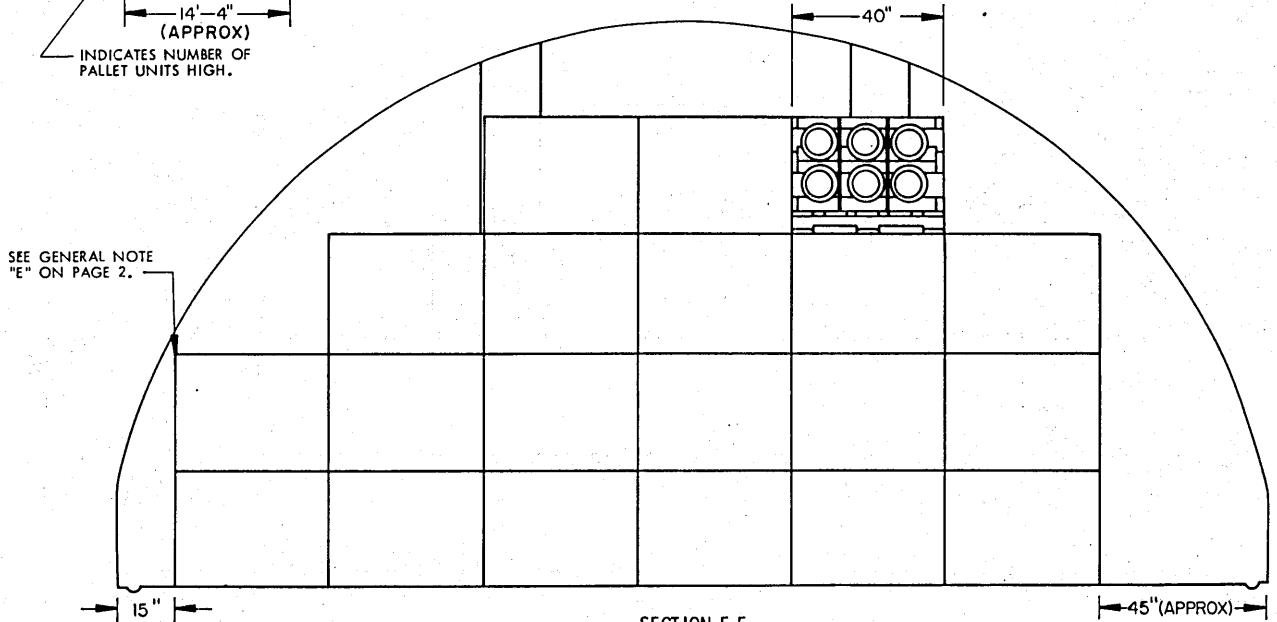

STORAGE PROCEDURES IN 80'-0" AND 40'-0" L X 25'-0" W X 12'-1-3/4" H ARCH TYPE MAGAZINES (IGLOO)

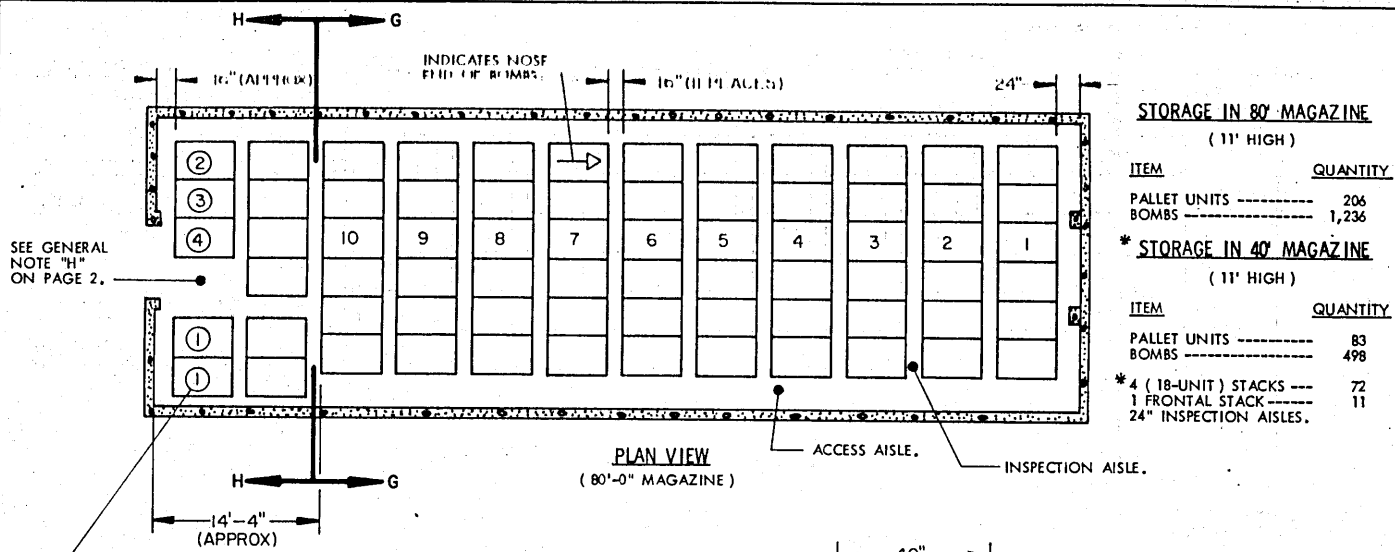

STORAGE IN 80' MAGAZINE
(11' HIGH)

| ITEM | QUANTITY |
|--------------|----------|
| PALLET UNITS | 206 |
| BOMBS | 1,236 |

*** STORAGE IN 40' MAGAZINE**
(11' HIGH)

| ITEM | QUANTITY |
|--------------|----------|
| PALLET UNITS | 83 |
| BOMBS | 498 |

* 4 (18-UNIT) STACKS --- 72
 1 FRONTAL STACK --- 11
 24" INSPECTION AISLES.

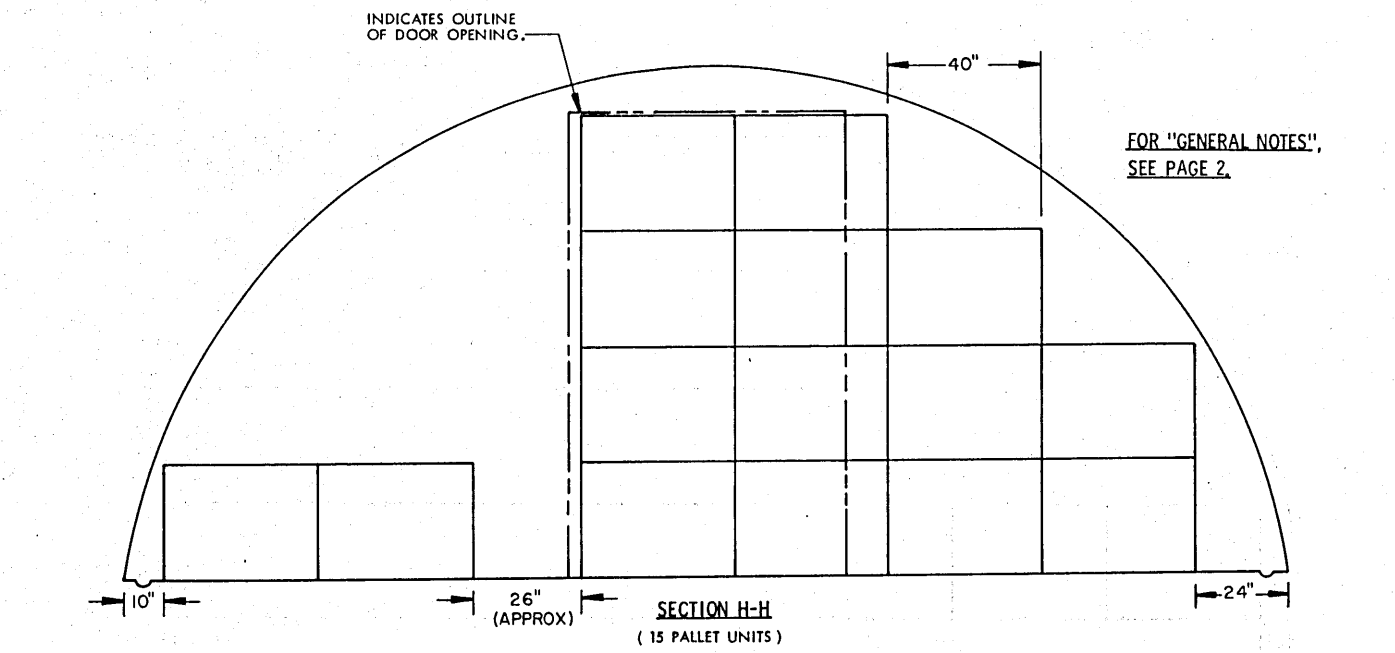
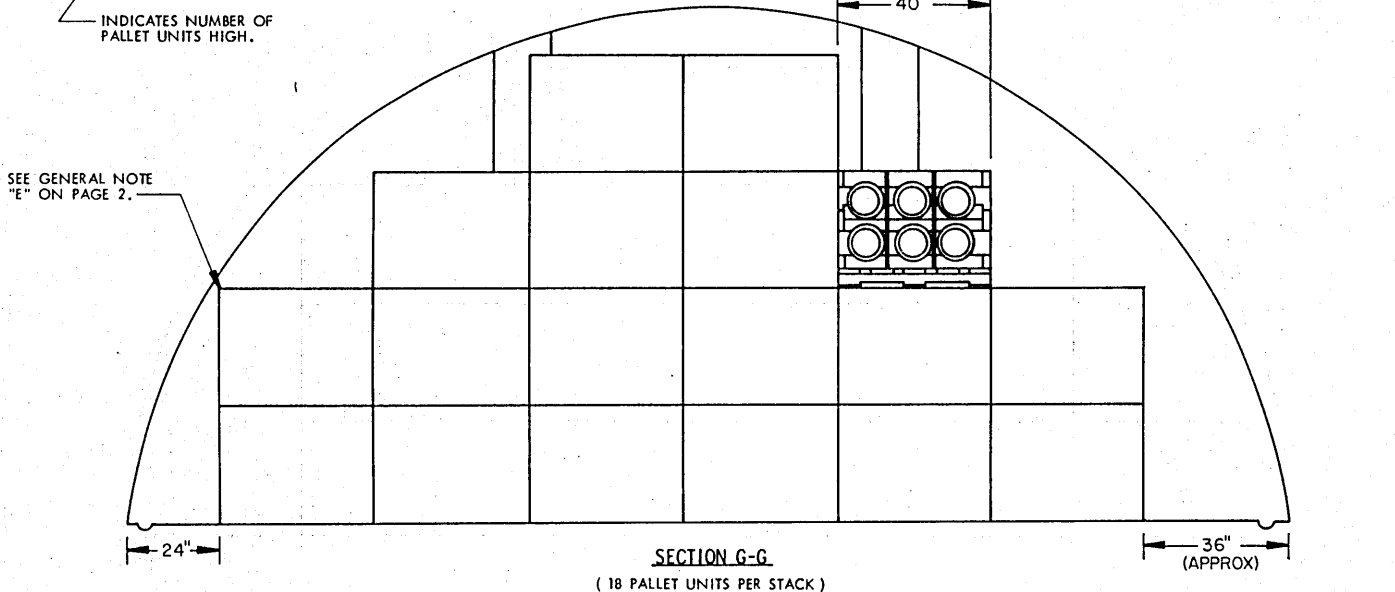

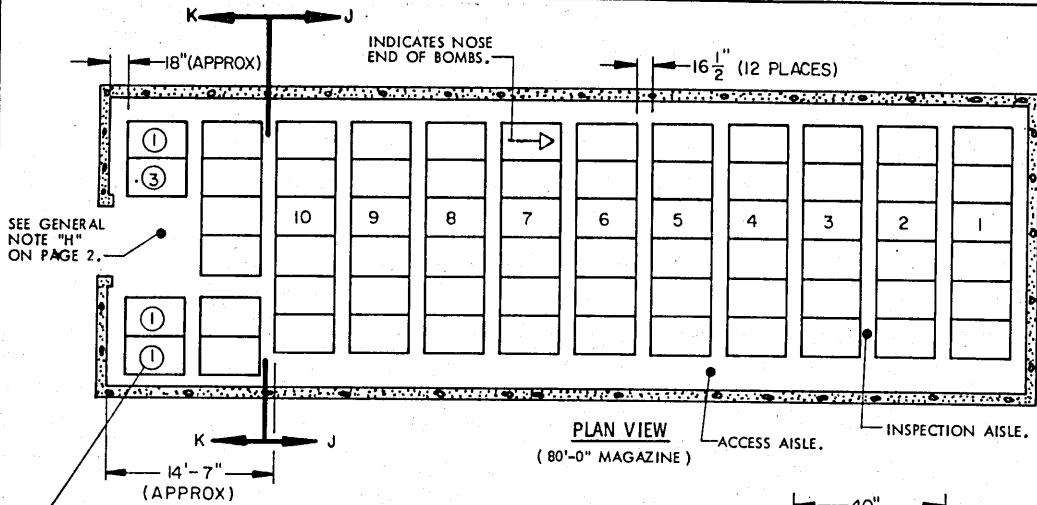

STORAGE IN 80' MAGAZINE

(10' HIGH)

| ITEM | QUANTITY |
|--------------|----------|
| PALLET UNITS | 168 |
| BOMBS | 1,008 |

*** STORAGE IN 40' MAGAZINE**

(10' HIGH)

| ITEM | QUANTITY |
|------------------------|----------|
| PALLET UNITS | 66 |
| BOMBS | 396 |
| * 4 (15-UNIT) STACKS | 60 |
| 1 FRONTAL STACK | 6 |
| 24" INSPECTION AISLES. | |

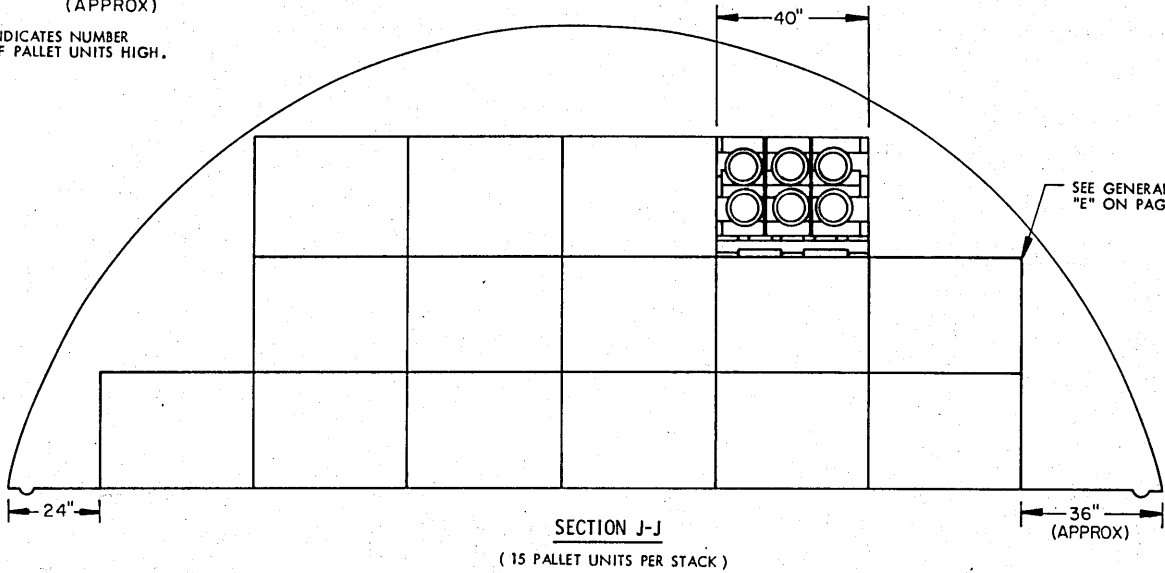

FOR "GENERAL NOTES", SEE PAGE 2.

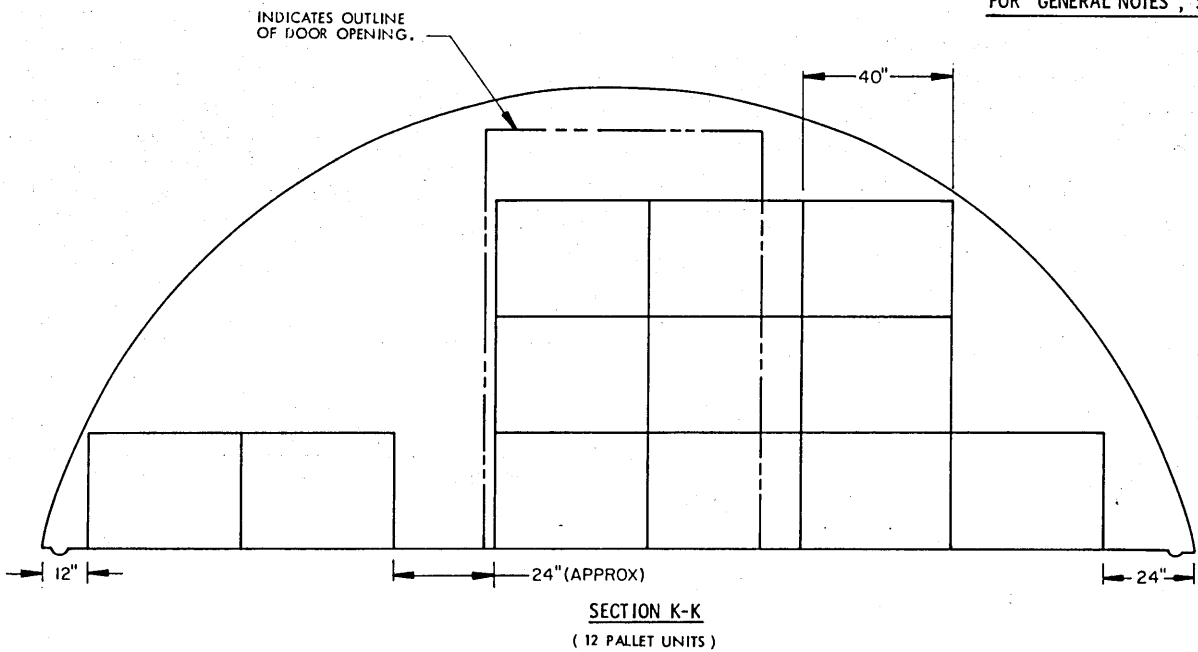

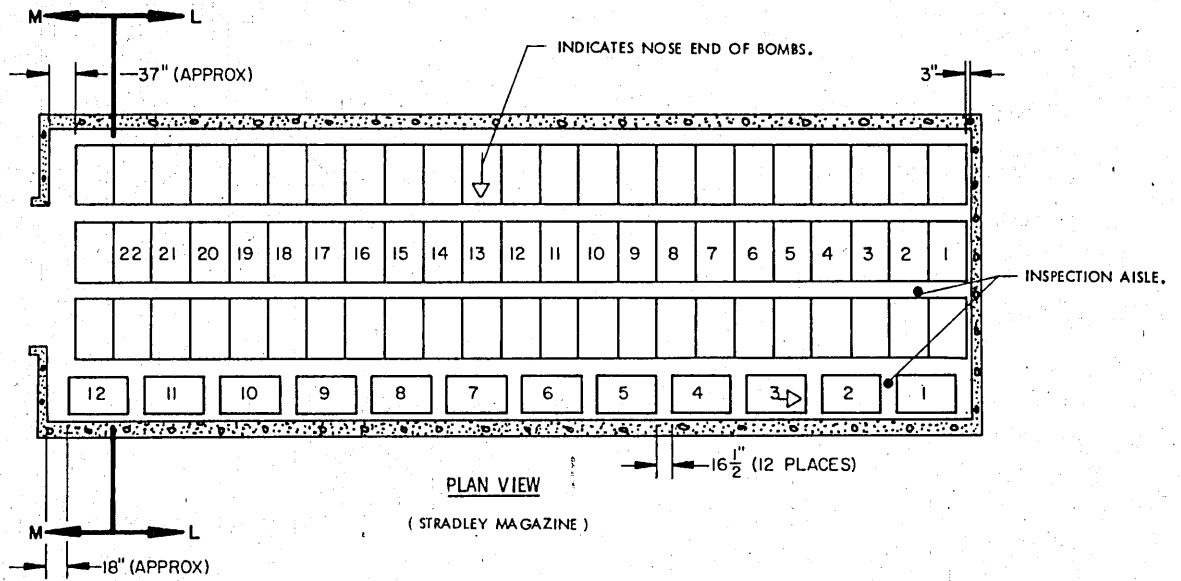

SEE GENERAL NOTE
"E" ON PAGE 2.

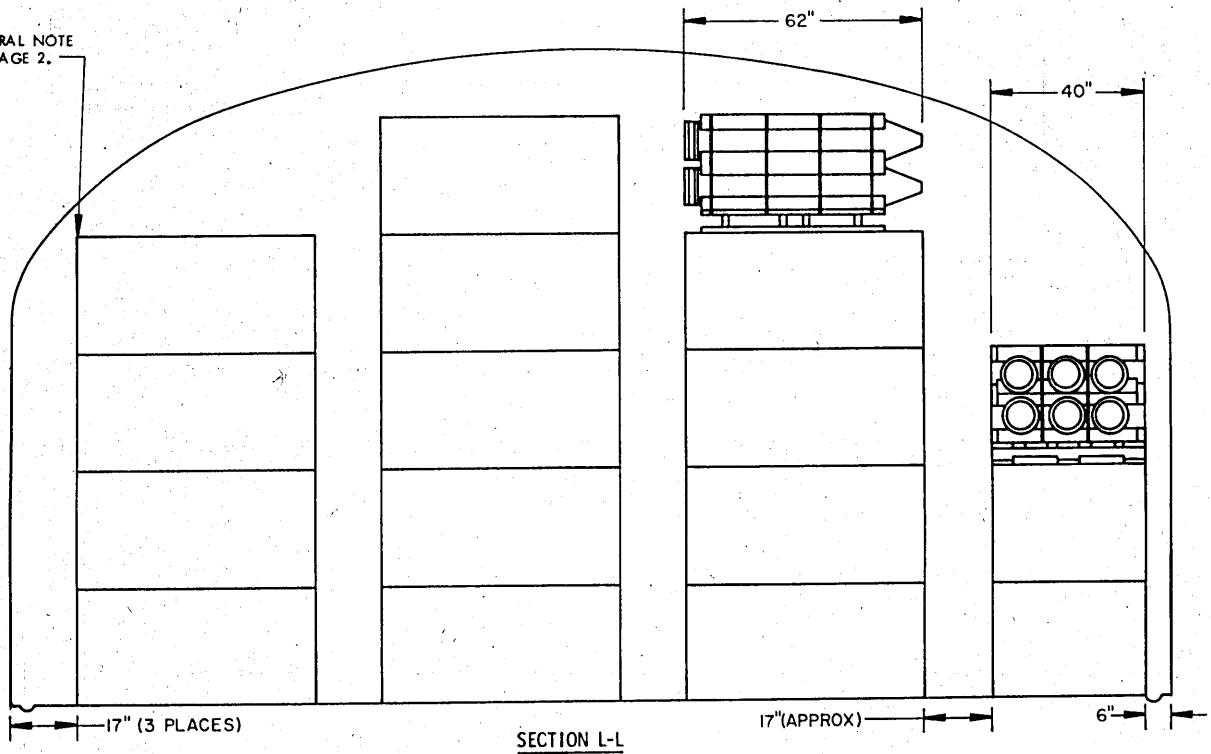

STORAGE IN STRADLEY MAGAZINE

| ITEM | QUANTITY |
|--------------------|----------|
| PALLET UNITS ----- | 354 |
| BOMBS ----- | 2,124 |

*** STORAGE IN OVAL ARCH MAGAZINE
89' LONG**

| ITEM | QUANTITY |
|--------------------|----------|
| PALLET UNITS ----- | 399 |
| BOMBS ----- | 2,394 |

- * 25 LATERAL (14-UNIT) STACKS-----350
- 13 LONGITUDINAL (3-UNIT) STACKS- 39
- 1 FRONTAL STACK ----- 10

CAUTION: SEE GENERAL NOTES "D"
AND "R" ON PAGE 2.

INDICATES OUTLINE OF
DOOR OPENING.

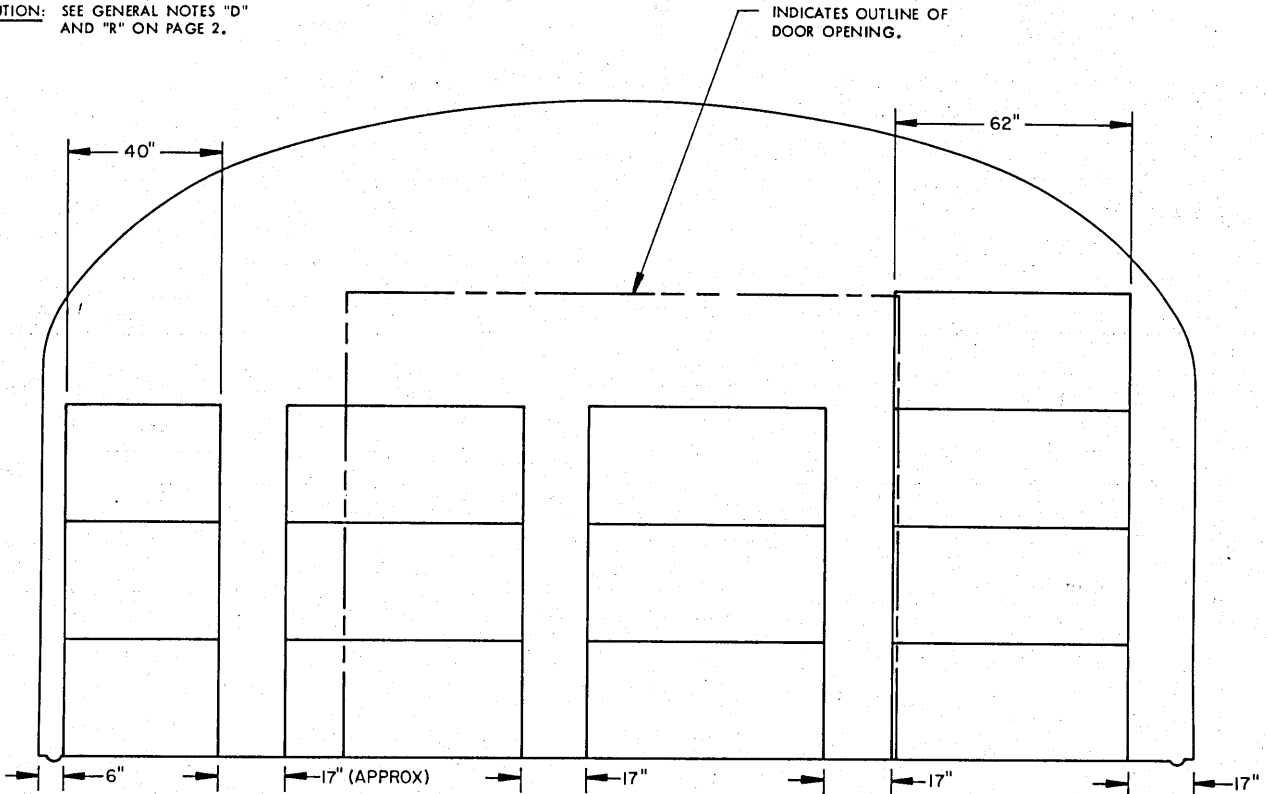

SECTION M-M

FOR "GENERAL NOTES", SEE PAGE 2.

STORAGE IN 52' DIA MAGAZINE

| ITEM | QUANTITY |
|--------------------|----------|
| PALLET UNITS ----- | 244 |
| BOMBS ----- | 1,464 |

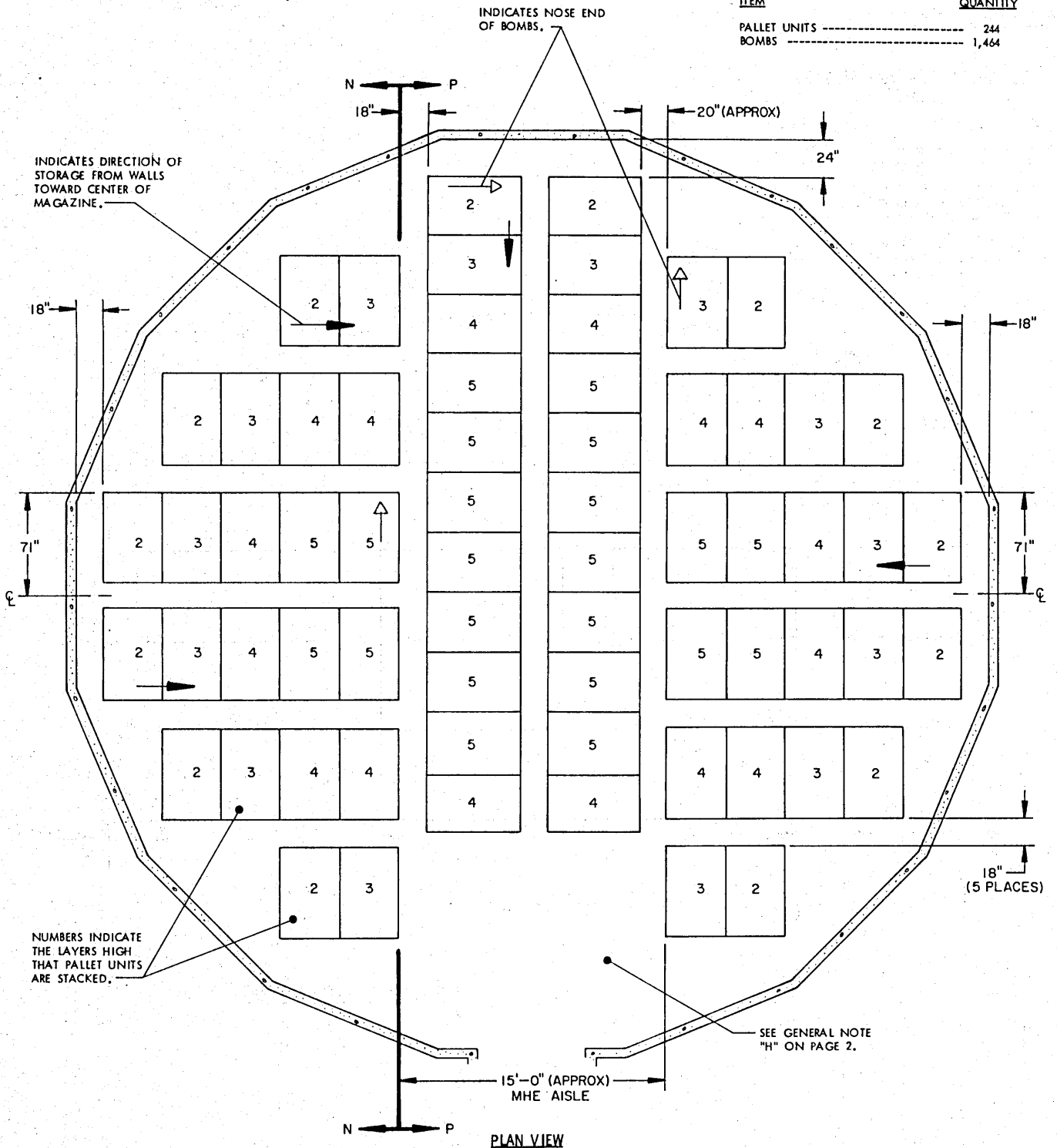

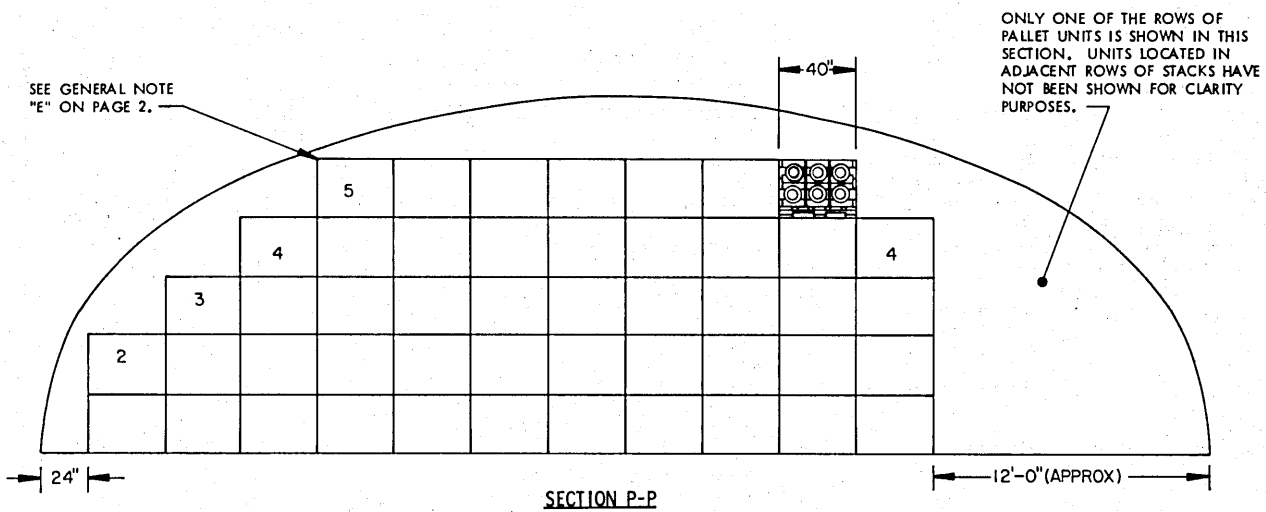
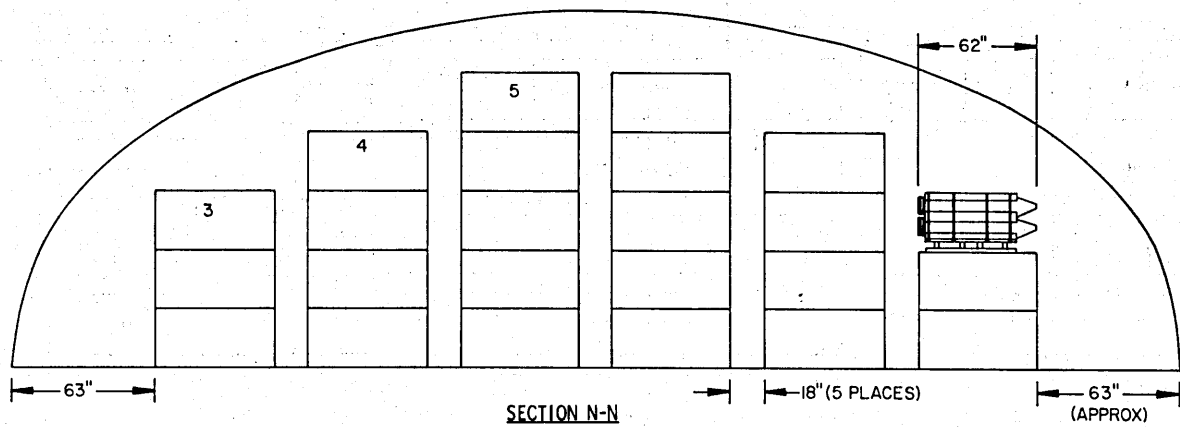

FOR "GENERAL NOTES", SEE PAGE 2.

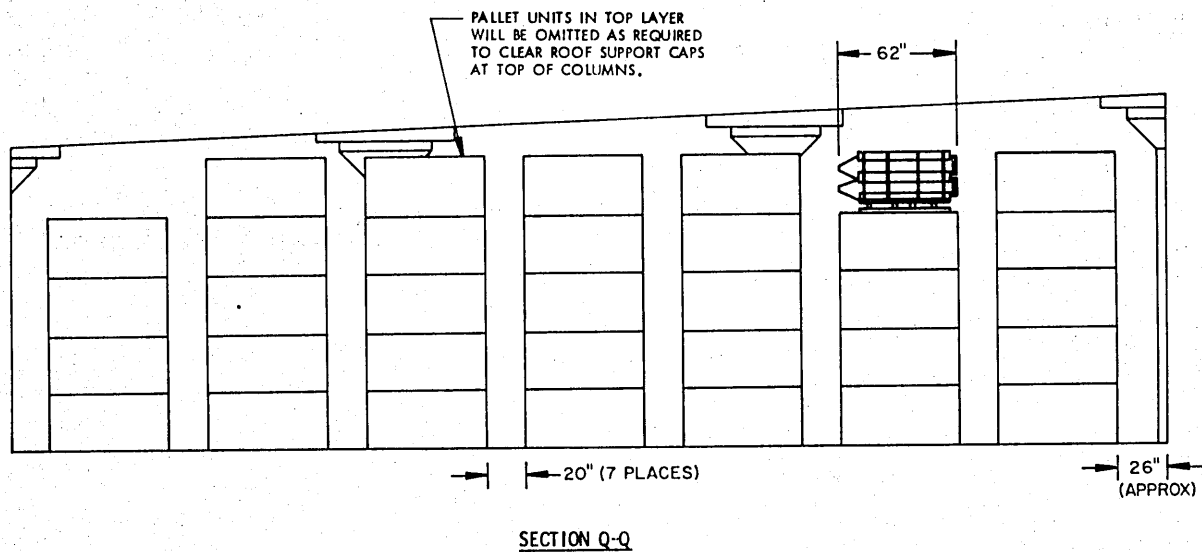
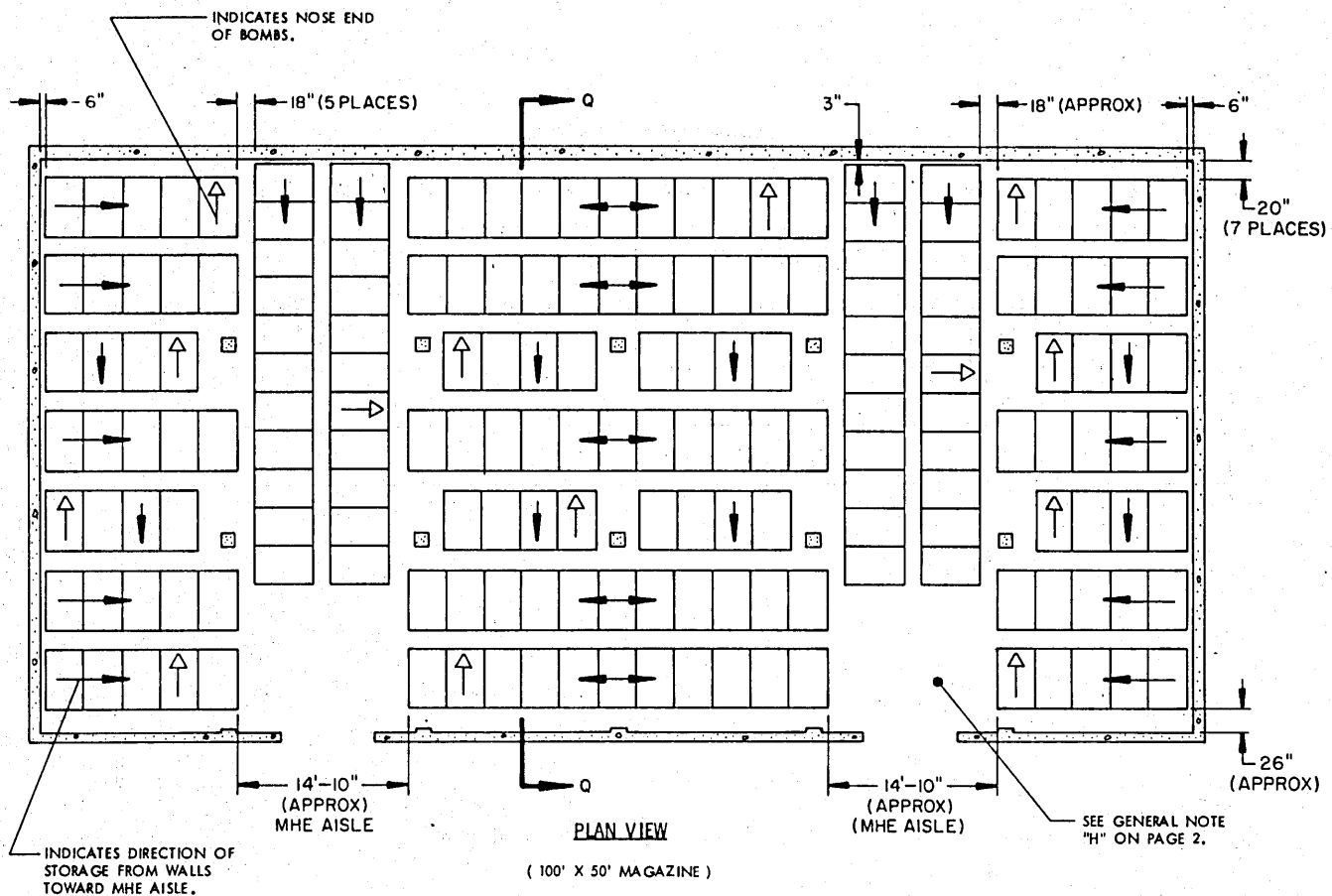

STORAGE IN 100' X 50' MAGAZINE

| <u>ITEM</u> | <u>QUANTITY</u> |
|--------------------|-----------------|
| PALLET UNITS ----- | 876 |
| BOMBS ----- | 5,256 |

CAUTION: SEE GENERAL NOTES "D" AND "R"
ON PAGE 2.

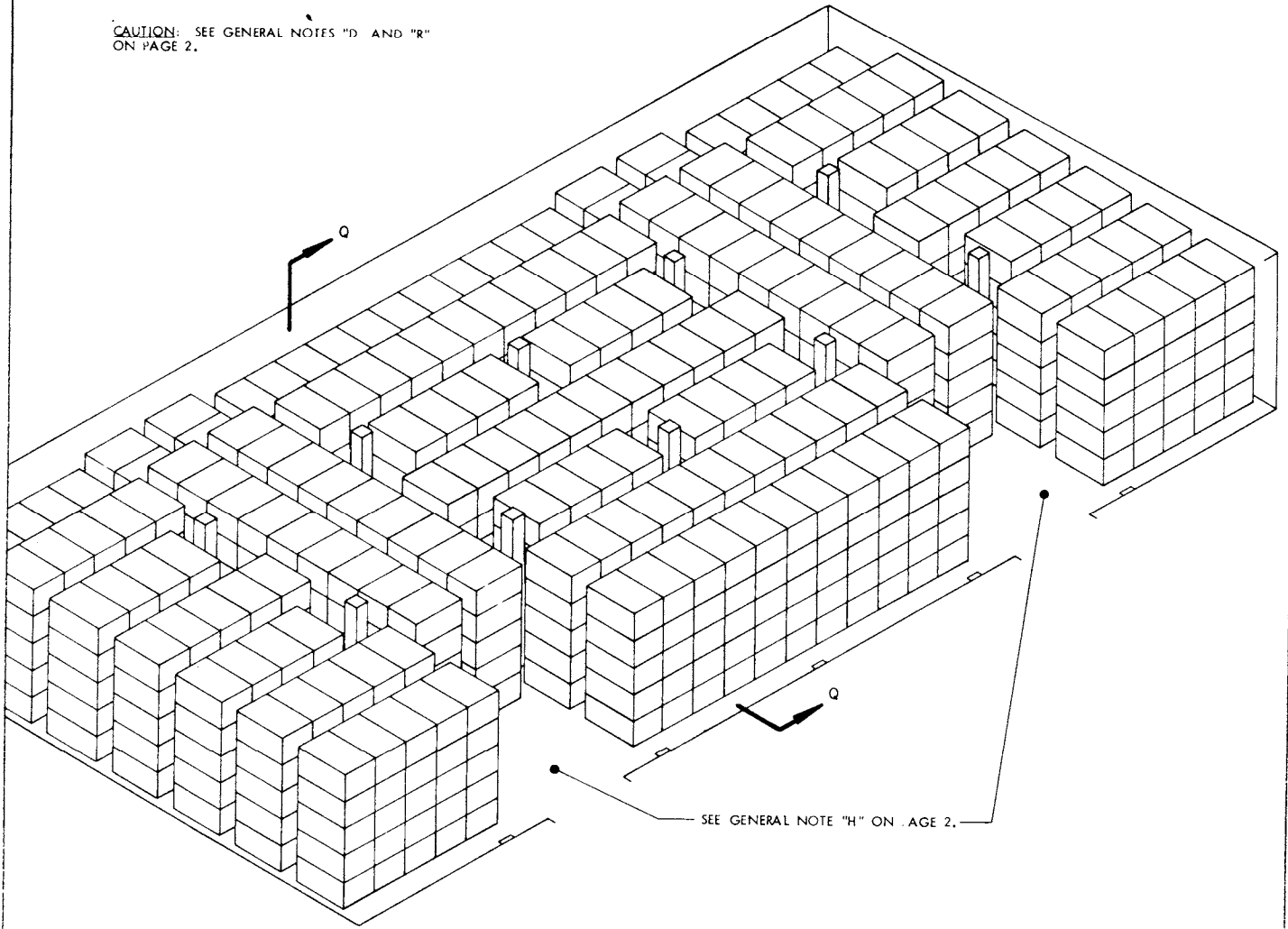

ISOMETRIC VIEW
(100' X 50' MAGAZINE)

FOR "GENERAL NOTES", SEE PAGE 2.

INDICATES NOSE END OF BOMBS. SEE GENERAL NOTE "5" ON PAGE 2.

INDICATES NOSE END OF BOMBS. SEE GENERAL NOTE "5" ON PAGE 2.

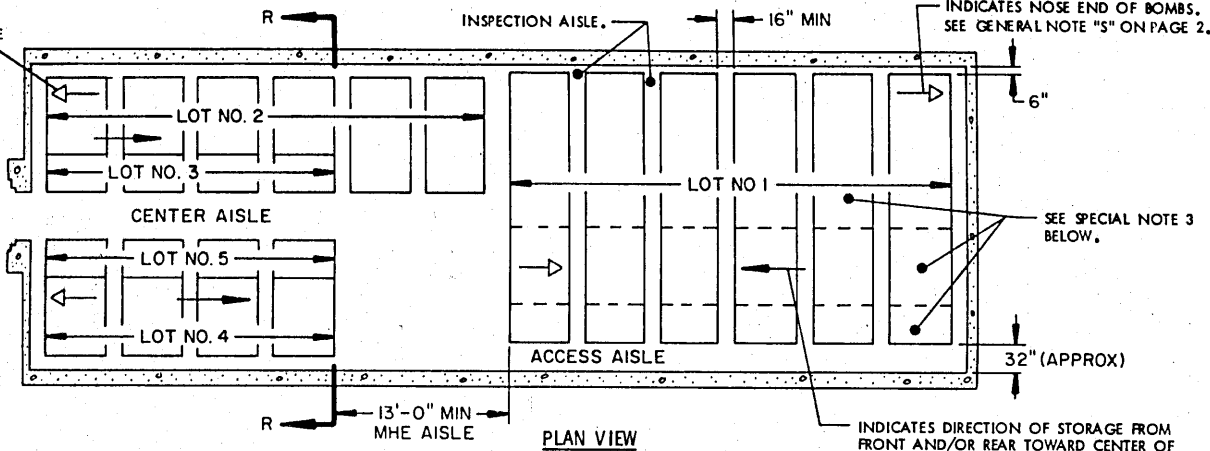

PLAN VIEW

INDICATES OUTLINE OF DOOR OPENING.

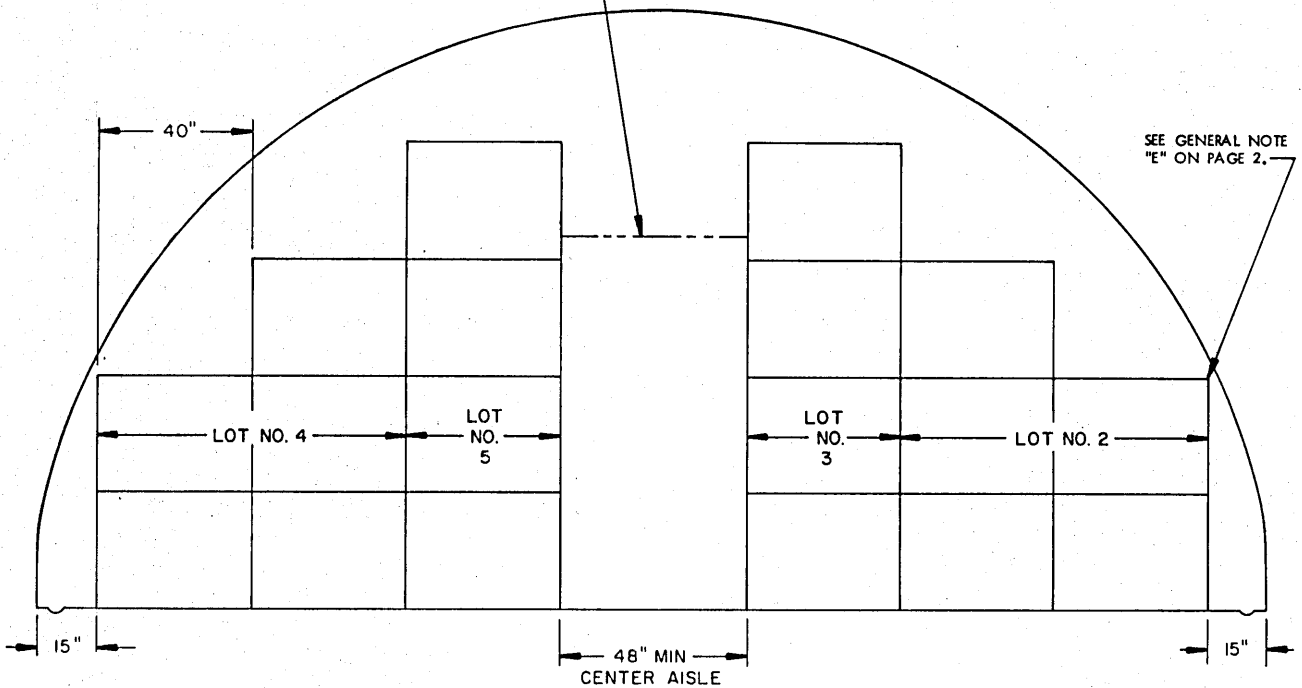

SECTION R-R

SPECIAL NOTES:

(SPECIAL NOTES CONTINUED)

1. THE STORAGE PLANS AND CONFIGURATIONS SHOWN ON THIS PAGE ARE TYPICAL ONLY AND APPLY TO RELATIVELY LARGE LOTS. ADAPTATIONS MAY BE MADE AS NUMBER AND SIZES OF LOTS TO BE STORED IN MAGAZINE REQUIRE.
2. AN INSPECTION AISLE NOT LESS THAN 16" WIDE MUST BE PROVIDED AT THE NOSE END AND AT THE BASE END OF THE BOMBS.
3. GENERALLY, THE LARGEST LOT SHOULD BE STORED IN THE REAR OF THE MAGAZINE. HOWEVER, THE REAR AREA MAY BE USED TO STORE MORE THAN ONE LOT BY ERECTING ROWS SIMILAR TO THOSE SHOWN IN THE FRONTAL AREA. A CENTER AISLE WILL NOT BE REQUIRED IN THE REAR AREA AS LONG AS EACH LOT IS ACCESSIBLE FOR REMOVAL AND INSPECTION/INVENTORY IN ACCORDANCE WITH OTHER CRITERIA SPECIFIED IN THESE SPECIAL NOTES AND IN THE GENERAL NOTES ON PAGE 2.
4. EACH LOT WITHIN THE MAGAZINE MUST BE ACCESSIBLE FOR MOVEMENT BY MHE. A SINGLE-LOT OF PALLET UNITS IS CONSIDERED "ACCESSIBLE" IF NO MORE THAN TWELVE (12) "LIFTS" OF ANOTHER LOT OR LOTS HAVE TO BE MADE TO GAIN ACCESS TO THAT LOT. A "LIFT" MAY CONSIST OF ONE (1) OR MORE PALLET UNITS, PROVIDING THE CAPACITY OF MHE PERMITS, AND SAFE HANDLING IS NOT JEOPARDIZED.
5. FOR STORAGE OF MULTIPLE LOTS, THE DISTANCE FROM THE SIDEWALL WILL BE BASED ON THE OVERHEAD CLEARANCE REQUIRED FOR MHE.
6. WHEN TWO LOTS ARE STORED ADJACENT TO EACH OTHER, WITH UNITS OF ONE LOT HAVING BOMBS PARALLEL TO AND SIDE BY SIDE WITH THE BOMBS IN THE OTHER LOT, THEY SHOULD BE SEPARATED BY AT LEAST 1" TO PROVIDE CLEARANCE FOR REMOVAL OF EITHER LOT.
7. EACH LOT MUST BE STORED TWO (2) UNITS (MINIMUM) WIDE TO ACCOMMODATE WIDTH OF MHE DURING OPERATIONS, EXCEPT FOR A ROW ADJACENT TO A CENTER/ACCESS AISLE.

(CONTINUED AT RIGHT)

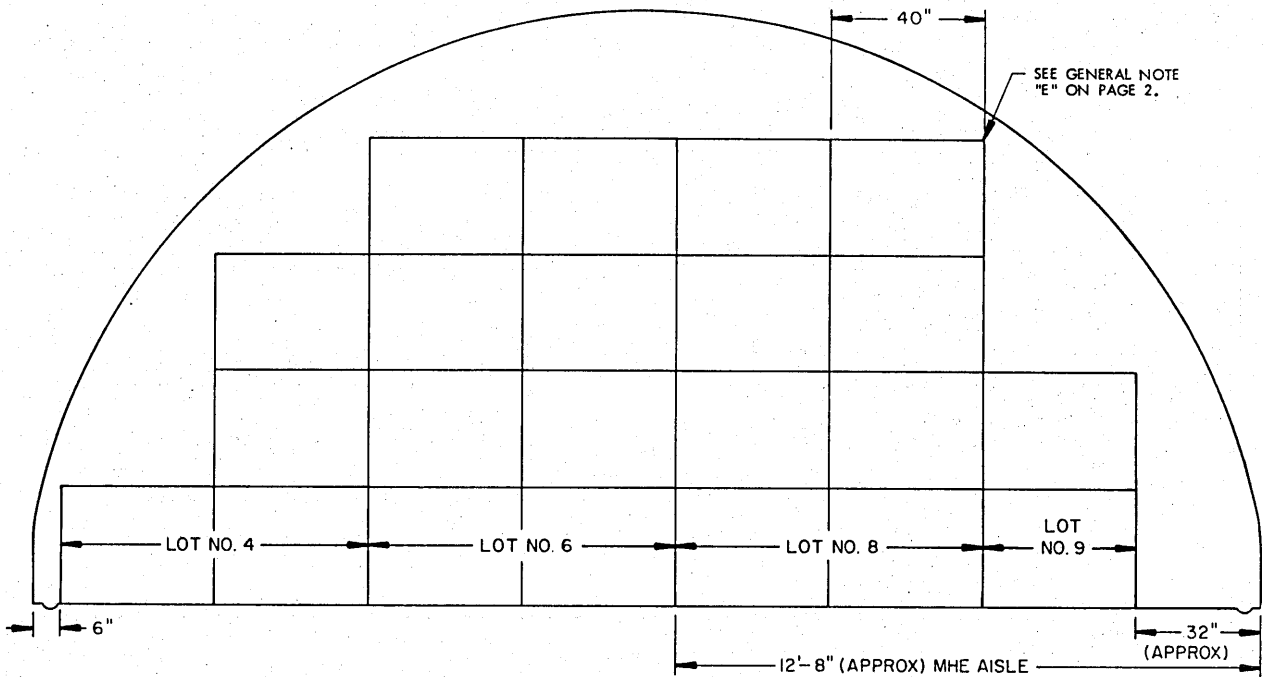
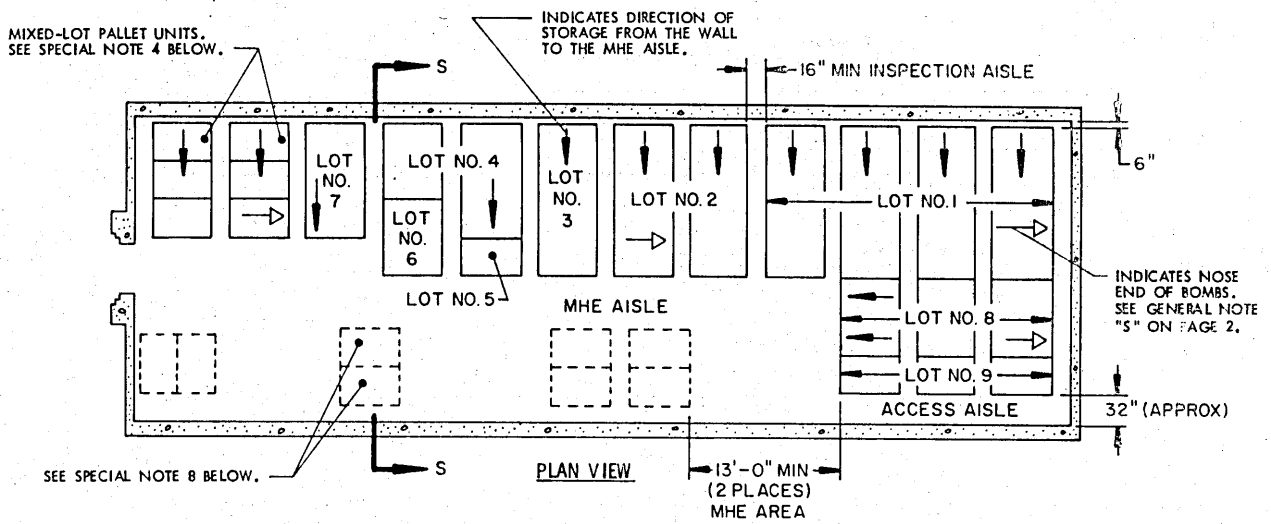

SECTION S-S

SPECIAL NOTES:

1. THE STORAGE PLANS AND CONFIGURATIONS SHOWN ON THIS PAGE ARE TYPICAL ONLY AND APPLY TO STORAGE OF NUMEROUS SMALL LOTS. ADAPTATIONS MAY BE MADE AS NUMBER AND SIZES OF LOTS TO BE STORED IN MAGAZINE REQUIRE.
2. AN INSPECTION AISLE NOT LESS THAN 16" WIDE MUST BE PROVIDED AT THE NOSE END AND AT THE BASE END OF THE BOMBS.
3. GENERALLY, THE LARGEST LOT SHOULD BE STORED IN THE REAR OF THE MAGAZINE. HOWEVER, THE REAR AREA MAY BE USED TO STORE MORE THAN ONE LOT BY ERECTING STACKS SIMILAR TO THOSE SHOWN IN THE FRONTAL AREA. AN MHE AISLE WILL BE REQUIRED ON ONE SIDE OF THE MAGAZINE, AND EACH LOT MUST BE ACCESSIBLE FOR REMOVAL AND INSPECTION/INVENTORY IN ACCORDANCE WITH OTHER CRITERIA SPECIFIED IN THESE SPECIAL NOTES AND IN THE GENERAL NOTES ON PAGE 2.
4. A MIXED-LOT PALLET UNIT MAY HAVE FROM TWO LOTS PER PALLET UNIT UPWARDS TO AS MANY DIFFERENT LOTS AS BOMBS WITHIN THAT UNIT. HOWEVER, ALL BOMBS AND LOTS WITHIN THE PALLET UNIT MUST HAVE THE SAME NATIONAL STOCK NUMBER AND CONDITION CODE.
5. EACH LOT WITHIN THE MAGAZINE MUST BE ACCESSIBLE FOR MOVEMENT BY MHE. PALLET UNITS OF A SINGLE-LOT OR MIXED-LOT PALLET UNITS ARE CONSIDERED "ACCESSIBLE" IF NO MORE THAN TWELVE (12) "LIFTS" OF ANOTHER LOT OR LOTS HAVE TO BE MADE TO GAIN ACCESS TO THE SINGLE-LOT OR MIXED-LOT UNITS. A "LIFT" MAY CONSIST OF ONE (1) OR MORE PALLET UNITS, PROVIDING THE CAPACITY OF MHE PERMITS, AND SAFE HANDLING IS NOT JEOPARDIZED.
6. FOR STORAGE OF MULTIPLE LOTS, THE DISTANCE FROM THE SIDEWALL WILL BE BASED ON THE OVERHEAD CLEARANCE REQUIRED FOR MHE.

(CONTINUED AT RIGHT)

(SPECIAL NOTES CONTINUED)

7. WHEN TWO LOTS ARE STORED ADJACENT TO EACH OTHER, WITH UNITS OF ONE LOT HAVING BOMBS PARALLEL TO AND SIDE BY SIDE WITH THE BOMBS IN THE OTHER LOT, THEY SHOULD BE SEPARATED BY AT LEAST 1" TO PROVIDE CLEARANCE FOR REMOVAL OF EITHER LOT.
8. AREAS ENCLOSED BY DOTTED LINES INDICATE LOCATIONS WHERE ADDITIONAL LOTS MAY BE STORED OR WHERE ADDITIONAL ITEMS MAY BE STORED, THAT ARE FROM THE LOT OR LOTS WHICH ARE DIRECTLY OR ALMOST DIRECTLY ACROSS THE CENTER AISLE ON THE OTHER SIDE OF THE MAGAZINE. COMPLIANCE WITH ALL OF THE MULTIPLE-LOT CRITERIA AS SET FORTH ON THIS PAGE MUST BE OBSERVED. THE SIZE OF THE LOTS BEING STORED AND THE CRITERIA OF SPECIAL NOTE 5, RELATIVE TO "12 LIFTS", WILL BE MAJOR FACTORS IMPACTING ON THE NUMBER OF UNIT LOADS THAT CAN BE STORED IN AN "ADDITIONAL STORAGE LOCATION". MORE OR FEWER STACKS THAN SHOWN MAY BE STORED AT ANY ONE OF THE ADDITIONAL STORAGE LOCATIONS. A 13-FOOT MHE OPERATING AREA HAS BEEN SPECIFIED FOR ACCESS TO EACH "ADDITIONAL LOCATION" BY FORKLIFT TRUCK. THIS OPERATING AREA IS BASED ON REQUIREMENTS OF FORKLIFT TRUCKS COMMONLY USED IN STORAGE MAGAZINES. THE MHE OPERATING AREA CAN BE ENLARGED AS REQUIRED TO SUIT AVAILABLE FORKLIFT TRUCKS, AND SHOULD BE MADE SMALLER IF AVAILABLE MHE PERMITS. A "CENTER AISLE" (SPACE BETWEEN STORAGE ON ONE SIDE OF A MAGAZINE AND AN "ADDITIONAL STORAGE LOCATION") IS TO BE AT LEAST 48 INCHES WIDE. AN AISLE SLIGHTLY WIDER THAN 48 INCHES WILL ENHANCE FORKLIFT TRUCK MOVEMENT WITHIN A MAGAZINE; HOWEVER, THIS AISLE SHOULD NOT BE MADE WIDER IF A LOSS IN STORAGE RESULTS.
9. WHEN PALLET UNITS MUST BE HANDLED FROM THE BASE END OF THE BOMBS FOR PLACEMENT OR REMOVAL FROM A STACK, SUCH AS IN LOTS 1, 8 AND 9, EACH LOT MUST BE STORED TWO (2) UNITS (MINIMUM) WIDE TO ACCOMMODATE WIDTH OF MHE DURING OPERATIONS, EXCEPT FOR A ROW ADJACENT TO AN MHE OR ACCESS AISLE.

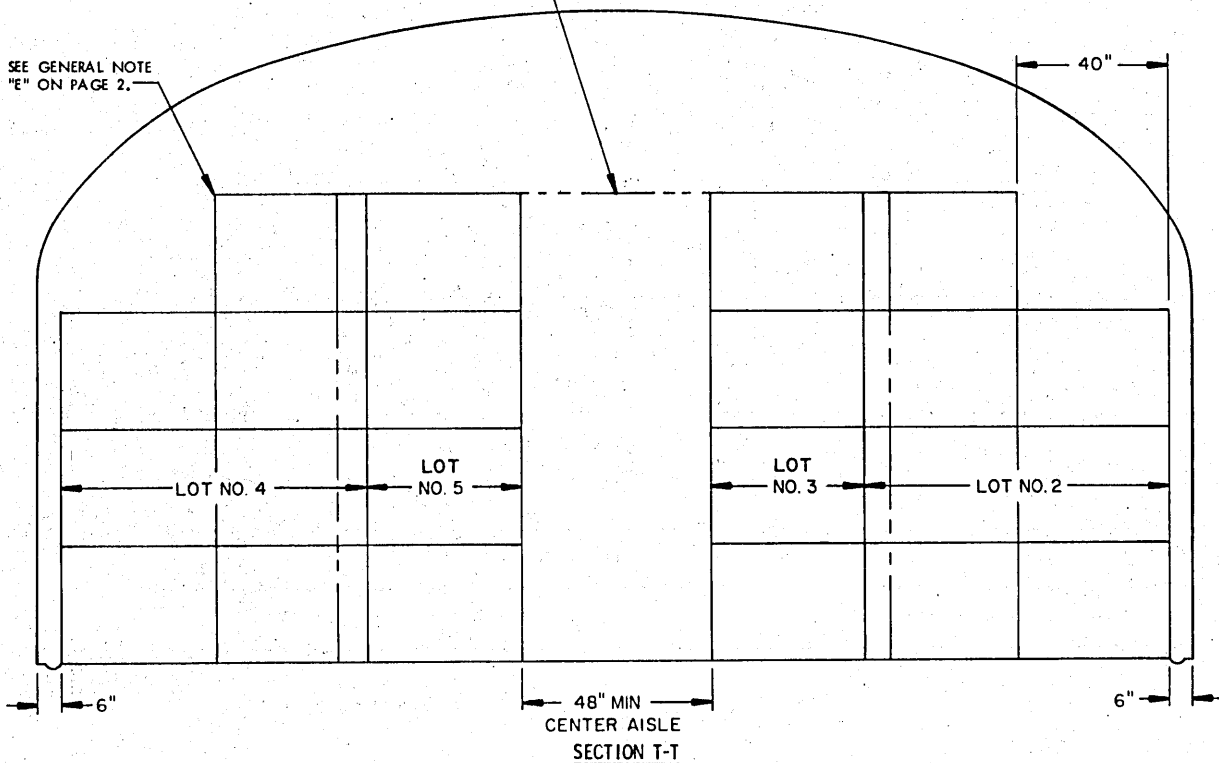
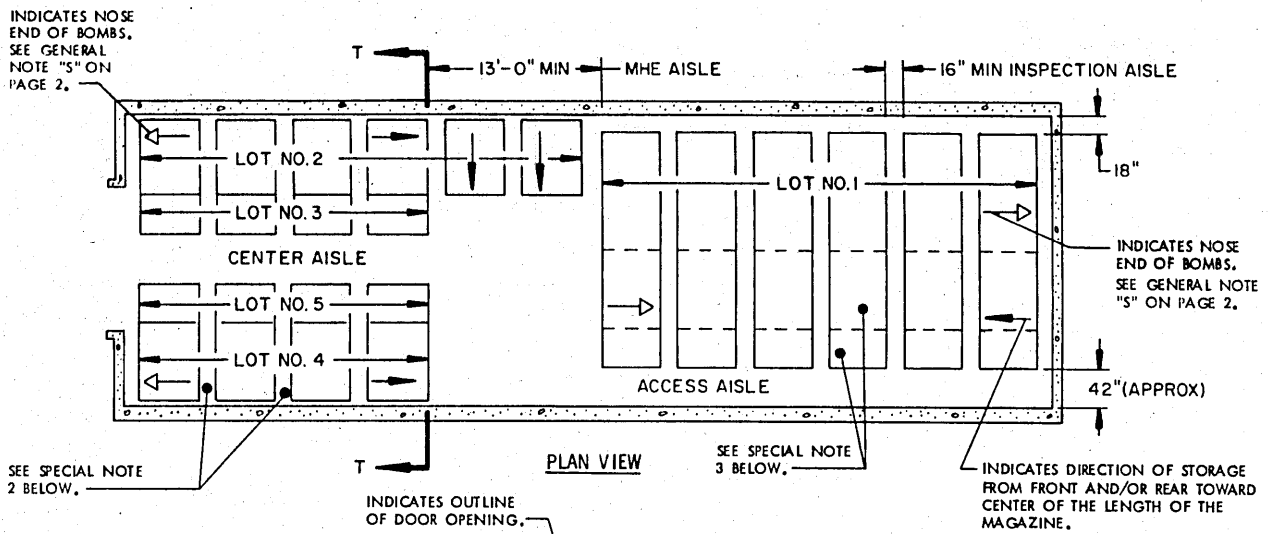

SPECIAL NOTES:

1. THE STORAGE PLANS AND CONFIGURATIONS SHOWN ON THIS PAGE ARE TYPICAL ONLY AND APPLY TO RELATIVELY LARGE LOTS. ADAPTATIONS MAY BE MADE AS NUMBER AND SIZES OF LOTS TO BE STORED IN MAGAZINE REQUIRE.
2. AN INSPECTION AISLE NOT LESS THAN 16" WIDE MUST BE PROVIDED AT THE NOSE END AND AT THE BASE END OF THE BOMBS.
3. GENERALLY, THE LARGEST LOT SHOULD BE STORED IN THE REAR OF THE MAGAZINE. HOWEVER, THE REAR AREA MAY BE USED TO STORE MORE THAN ONE LOT BY ERECTING ROWS SIMILAR TO THOSE SHOWN IN THE FRONTAL AREA. A CENTER AISLE WILL NOT BE REQUIRED IN THE REAR AREA AS LONG AS EACH LOT IS ACCESSIBLE FOR REMOVAL AND INSPECTION/INVENTORY IN ACCORDANCE WITH OTHER CRITERIA SPECIFIED IN THESE SPECIAL NOTES AND IN THE GENERAL NOTES ON PAGE 2.
4. EACH LOT WITHIN THE MAGAZINE MUST BE ACCESSIBLE FOR MOVEMENT BY MHE. A SINGLE-LOT OF PALLET UNITS IS CONSIDERED "ACCESSIBLE" IF NOT MORE THAN TWELVE (12) "LIFTS" OF ANOTHER LOT OR LOTS HAVE TO BE MADE TO GAIN ACCESS TO THAT LOT. A "LIFT" MAY CONSIST OF ONE (1) OR MORE PALLET UNITS, PROVIDING THE CAPACITY OF MHE PERMITS, AND SAFE HANDLING IS NOT JEOPARDIZED.
5. FOR STORAGE OF MULTIPLE LOTS, THE DISTANCE FROM THE SIDE WALL WILL BE BASED ON THE OVERHEAD CLEARANCE REQUIRED FOR MHE.

(CONTINUED AT RIGHT)

(SPECIAL NOTES CONTINUED)

6. WHEN TWO LOTS ARE STORED ADJACENT TO EACH OTHER, WITH UNITS OF ONE LOT HAVING BOMBS PARALLEL TO AND SIDE BY SIDE WITH THE BOMBS IN THE OTHER LOT, THEY SHOULD BE SEPARATED BY AT LEAST 1" TO PROVIDE CLEARANCE FOR REMOVAL OF EITHER LOT.
7. EACH LOT MUST BE STORED TWO (2) UNITS (MINIMUM) WIDE TO ACCOMMODATE WIDTH OF MHE DURING OPERATIONS, EXCEPT FOR A ROW ADJACENT TO A CENTER/ACCESS AISLE.

MIXED-LOT PALLET UNITS.
SEE SPECIAL NOTE 4 BELOW.

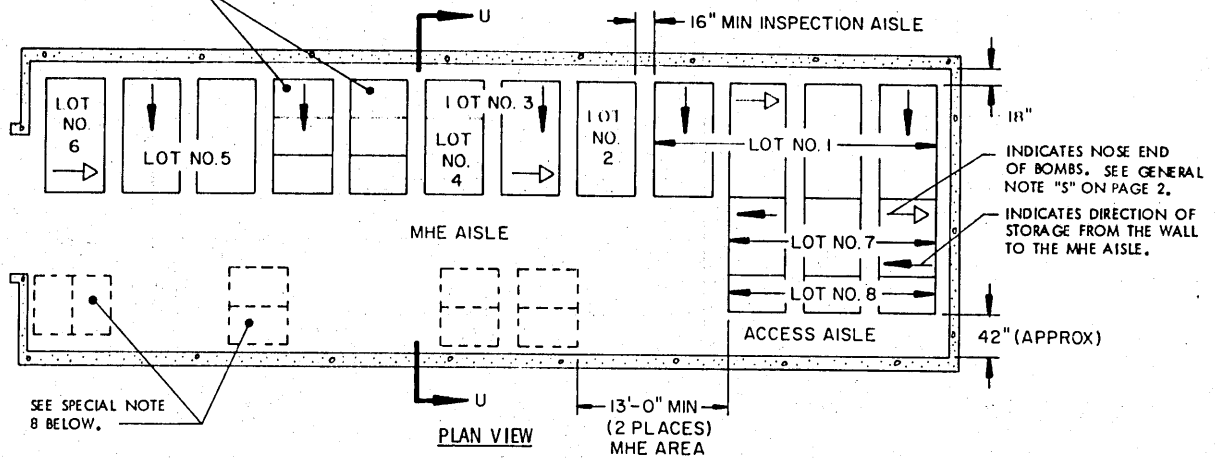

SEE GENERAL NOTE "E" ON PAGE 2.

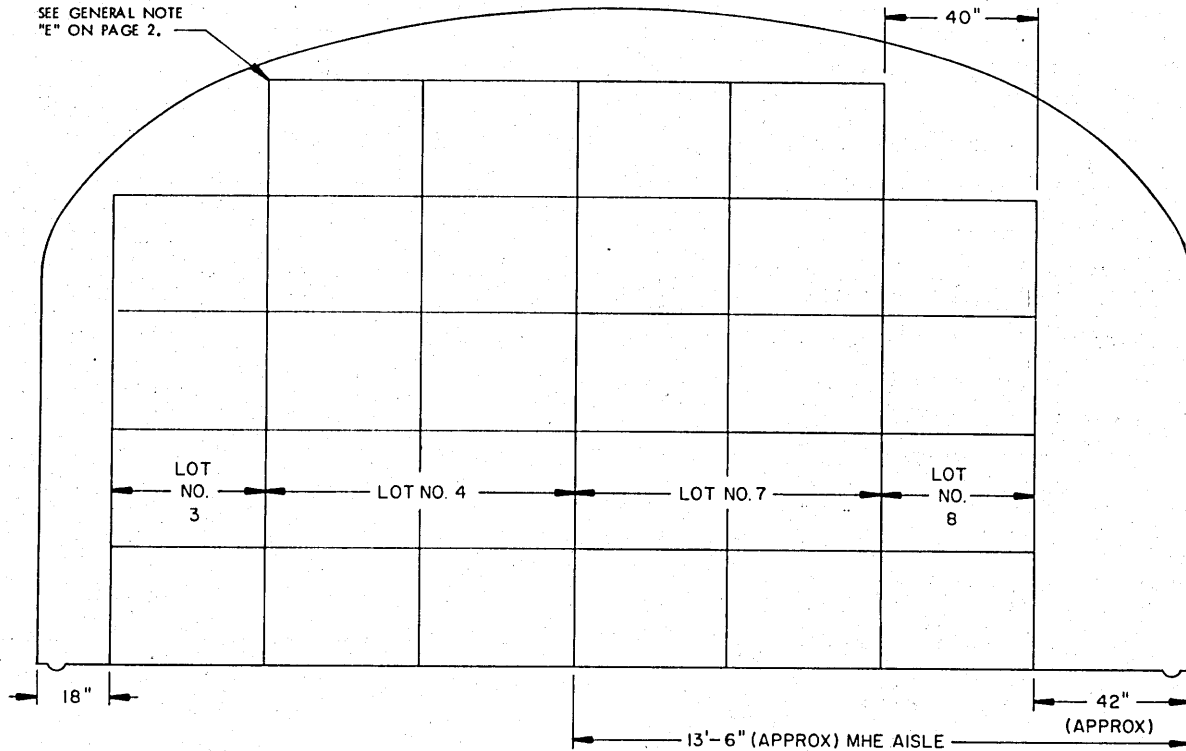

SPECIAL NOTES:

SECTION U-U

(SPECIAL NOTES CONTINUED)

1. THE STORAGE PLANS AND CONFIGURATIONS SHOWN ON THIS PAGE ARE TYPICAL ONLY AND APPLY TO STORAGE OF NUMEROUS SMALL LOTS. ADAPTATIONS MAY BE MADE AS NUMBER AND SIZES OF LOTS TO BE STORED IN MAGAZINE REQUIRE.
2. AN INSPECTION AISLE NOT LESS THAN 16" WIDE MUST BE PROVIDED AT THE NOSE END AND AT THE BASE END OF THE BOMBS.
3. GENERALLY, THE LARGEST LOT SHOULD BE STORED IN THE REAR OF THE MAGAZINE. HOWEVER, THE REAR AREA MAY BE USED TO STORE MORE THAN ONE LOT BY ERECTING STACKS SIMILAR TO THOSE SHOWN IN THE FRONTAL AREA. AN MHE AISLE WILL BE REQUIRED ON ONE SIDE OF THE MAGAZINE, AND EACH LOT MUST BE ACCESSIBLE FOR REMOVAL AND INSPECTION/INVENTORY IN ACCORDANCE WITH OTHER CRITERIA SPECIFIED IN THESE SPECIAL NOTES AND IN THE GENERAL NOTES ON PAGE 2.
4. A MIXED-LOT PALLET UNIT MAY HAVE FROM TWO LOTS PER PALLET UNIT UPWARDS TO AS MANY DIFFERENT LOTS AS BOMBS WITHIN THAT UNIT. HOWEVER, ALL BOMBS AND LOTS WITHIN THE PALLET UNIT MUST HAVE THE SAME NATIONAL STOCK NUMBER AND CONDITION CODE.
5. EACH LOT WITHIN THE MAGAZINE MUST BE ACCESSIBLE FOR MOVEMENT BY MHE. PALLET UNITS OF A SINGLE-LOT OR MIXED-LOT PALLET UNITS ARE CONSIDERED "ACCESSIBLE" IF NO MORE THAN TWELVE (12) "LIFTS" OF ANOTHER LOT OR LOTS HAVE TO BE MADE TO GAIN ACCESS TO THE SINGLE-LOT OR MIXED-LOT UNITS. A "LIFT" MAY CONSIST OF ONE (1) OR MORE PALLET UNITS, PROVIDING THE CAPACITY OF MHE PERMITS, AND SAFE HANDLING IS NOT JEOPARDIZED.
6. FOR STORAGE OF MULTIPLE LOTS, THE DISTANCE FROM THE SIDEWALL WILL BE BASED ON THE OVERHEAD CLEARANCE REQUIRED FOR MHE.
7. WHEN TWO LOTS ARE STORED ADJACENT TO EACH OTHER, WITH UNITS OF ONE LOT HAVING BOMBS PARALLEL TO AND SIDE BY SIDE WITH THE BOMBS IN THE OTHER LOT, THEY SHOULD BE SEPARATED BY AT LEAST 1" TO PROVIDE CLEARANCE FOR REMOVAL OF EITHER LOT.
8. AREAS INCLOSED BY DOTTED LINES INDICATE LOCATIONS WHERE ADDITIONAL LOTS MAY BE STORED OR WHERE ADDITIONAL ITEMS MAY BE STORED, THAT ARE FROM THE LOT OR LOTS WHICH ARE DIRECTLY OR ALMOST DIRECTLY ACROSS THE CENTER AISLE ON THE OTHER SIDE OF THE MAGAZINE. COMPLIANCE WITH ALL OF THE MULTIPLE-LOT CRITERIA AS SET FORTH ON THIS PAGE MUST BE OBSERVED. THE SIZE OF THE LOTS BEING STORED AND THE CRITERIA OF SPECIAL NOTE 5, RELATIVE TO "12 LIFTS", WILL BE MAJOR FACTORS IMPACTING ON THE NUMBER OF UNIT LOADS THAT CAN BE STORED IN AN "ADDITIONAL STORAGE LOCATION". MORE OR FEWER STACKS THAN SHOWN MAY BE STORED AT ANY ONE OF THE ADDITIONAL STORAGE LOCATIONS. A 13-FOOT MHE OPERATING AREA HAS BEEN SPECIFIED FOR ACCESS TO EACH "ADDITIONAL LOCATION" BY FORKLIFT TRUCK. THIS OPERATING AREA IS BASED ON REQUIREMENTS OF FORKLIFT TRUCKS COMMONLY USED IN STORAGE MAGAZINES. THE MHE OPERATING AREA CAN BE ENLARGED AS REQUIRED TO SUIT AVAILABLE FORKLIFT TRUCKS, AND SHOULD BE MADE SMALLER IF AVAILABLE MHE PERMITS. A "CENTER AISLE" (SPACE BETWEEN STORAGE ON ONE SIDE OF A MAGAZINE AND AN "ADDITIONAL STORAGE LOCATION") IS TO BE AT LEAST 48 INCHES WIDE. AN AISLE SLIGHTLY WIDER THAN 48 INCHES WILL ENHANCE FORKLIFT TRUCK MOVEMENT WITHIN A MAGAZINE; HOWEVER, THIS AISLE SHOULD NOT BE MADE WIDER IF A LOSS IN STORAGE RESULTS.
9. WHEN PALLET UNITS MUST BE HANDLED FROM THE BASE END OF THE BOMBS FOR PLACEMENT OR REMOVAL FROM A STACK, SUCH AS IN LOTS 1, 7 AND 8, EACH LOT MUST BE STORED TWO (2) UNITS (MINIMUM) WIDE TO ACCOMMODATE WIDTH OF MHE DURING OPERATIONS, EXCEPT FOR A ROW ADJACENT TO AN MHE OR ACCESS AISLE.

(CONTINUED AT RIGHT)

TYPICAL MULTIPLE-LOT STORAGE IN STRADLEY AND OVAL ARCH TYPE MAGAZINES

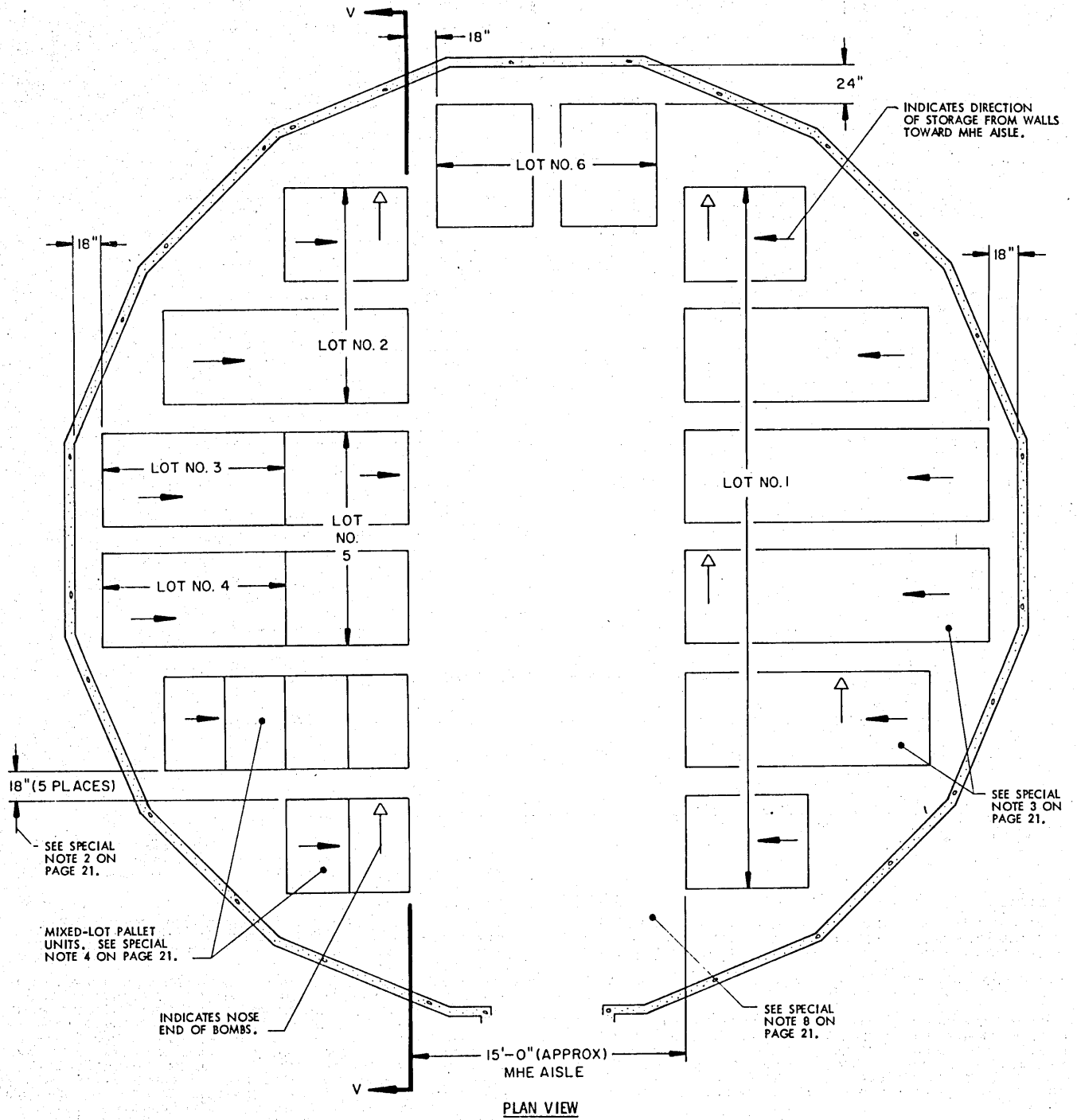

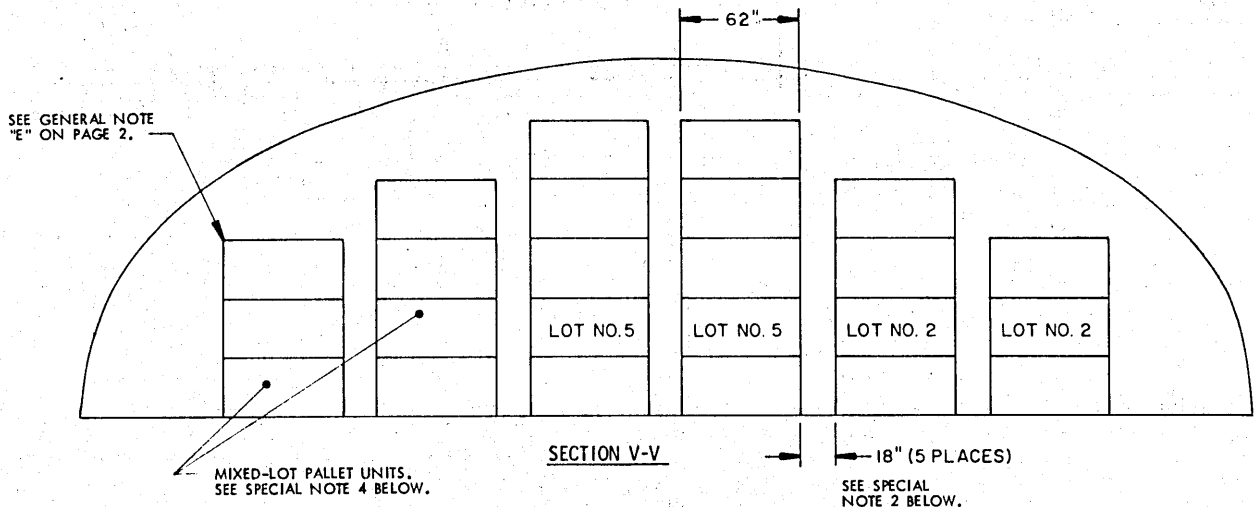

SPECIAL NOTES:

1. THE STORAGE PLANS AND CONFIGURATIONS SHOWN ARE TYPICAL ONLY. ADAPTATIONS MAY BE MADE AS NUMBER AND SIZES OF LOTS TO BE STORED IN MAGAZINE REQUIRE.
2. AN INSPECTION AISLE NOT LESS THAN 16" WIDE MUST BE PROVIDED AT THE NOSE END AND AT THE BASE END OF THE BOMBS.
3. GENERALLY, THE LARGEST LOT SHOULD BE STORED ON ONE SIDE OF THE MAGAZINE. HOWEVER, BOTH SIDES MAY BE USED TO STORE MORE THAN ONE LOT BY ERECTING ROWS SIMILAR TO THOSE SHOWN ON THE LEFT SIDE. EACH ADDITIONAL LOT MUST BE ACCESSIBLE FOR REMOVAL AND INSPECTION/INVENTORY IN ACCORDANCE WITH OTHER CRITERIA SPECIFIED IN THESE SPECIAL NOTES AND IN THE GENERAL NOTES ON PAGE 2.
4. A MIXED-LOT PALLET UNIT MAY HAVE FROM TWO LOTS PER PALLET UNIT UPWARDS TO AS MANY DIFFERENT LOTS AS BOMBS WITHIN THAT UNIT. HOWEVER, ALL BOMBS AND LOTS WITHIN THE PALLET UNIT MUST HAVE THE SAME NATIONAL STOCK NUMBER AND CONDITION CODE.
5. EACH LOT WITHIN THE MAGAZINE MUST BE ACCESSIBLE FOR MOVEMENT BY MHE. PALLET UNITS OF A SINGLE-LOT OR MIXED-LOT PALLET UNITS ARE CONSIDERED "ACCESSIBLE" IF NO MORE THAN TWELVE (12) "LIFTS" OF ANOTHER LOT OR LOTS HAVE TO BE MADE TO GAIN ACCESS TO THE SINGLE-LOT OR MIXED-LOT UNITS. A "LIFT" MAY CONSIST OF ONE (1) OR MORE PALLET UNITS, PROVIDING THE CAPACITY OF MHE PERMITS, AND SAFE HANDLING IS NOT JEOPARDIZED.
6. FOR STORAGE OF MULTIPLE LOTS, THE DISTANCE FROM THE SIDEWALL WILL BE BASED ON THE OVERHEAD CLEARANCE REQUIRED FOR MHE.
7. WHEN TWO LOTS ARE STORED ADJACENT TO EACH OTHER, WITH UNITS OF ONE LOT HAVING BOMBS PARALLEL TO AND SIDE BY SIDE WITH THE BOMBS IN THE OTHER LOT, THEY SHOULD BE SEPARATED BY AT LEAST 1" TO PROVIDE CLEARANCE FOR REMOVAL OF EITHER LOT.
8. THE MHE AISLE MAY BE USED TO STORE ONE OR MORE STACKS OF ADDITIONAL LOTS OR ADDITIONAL ITEMS THAT ARE FROM A LOT ADJACENT TO THE MHE AISLE. THIS ADDITIONAL STORAGE IS TO BE ARRANGED IN A MANNER SIMILAR TO ARRANGEMENTS DEPICTED ON PAGES 17 AND 19 FOR THE "ADDITIONAL STORAGE LOCATIONS" (SHOWN BY DOTTED LINES). ADEQUATE SPACE FOR MHE OPERATIONS, AS DESCRIBED ON PAGES 17 AND 19, MUST BE MADE AVAILABLE FOR THE ADDITIONAL STORAGE. ALSO, COMPLIANCE WITH ALL OF THE MULTIPLE-LOT CRITERIA AS SET FORTH ON THIS PAGE MUST BE OBSERVED.

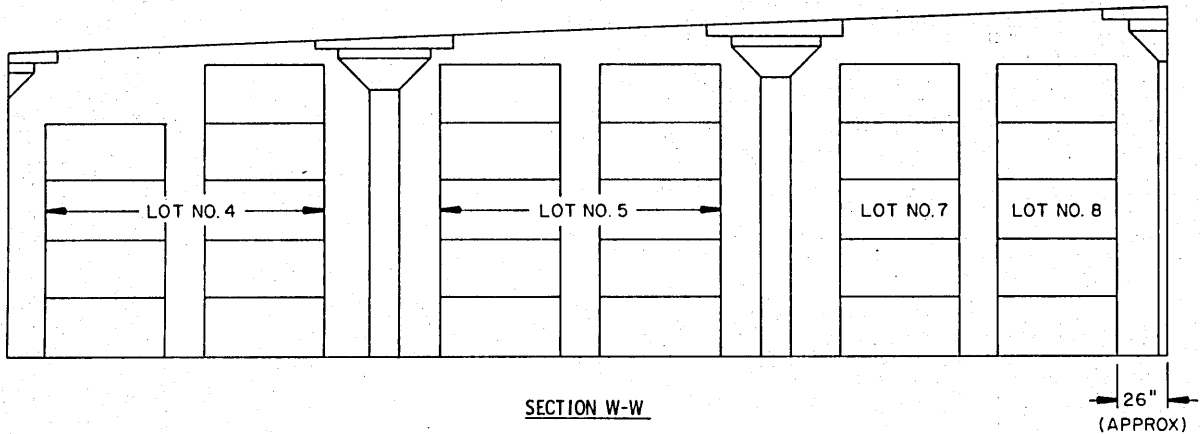
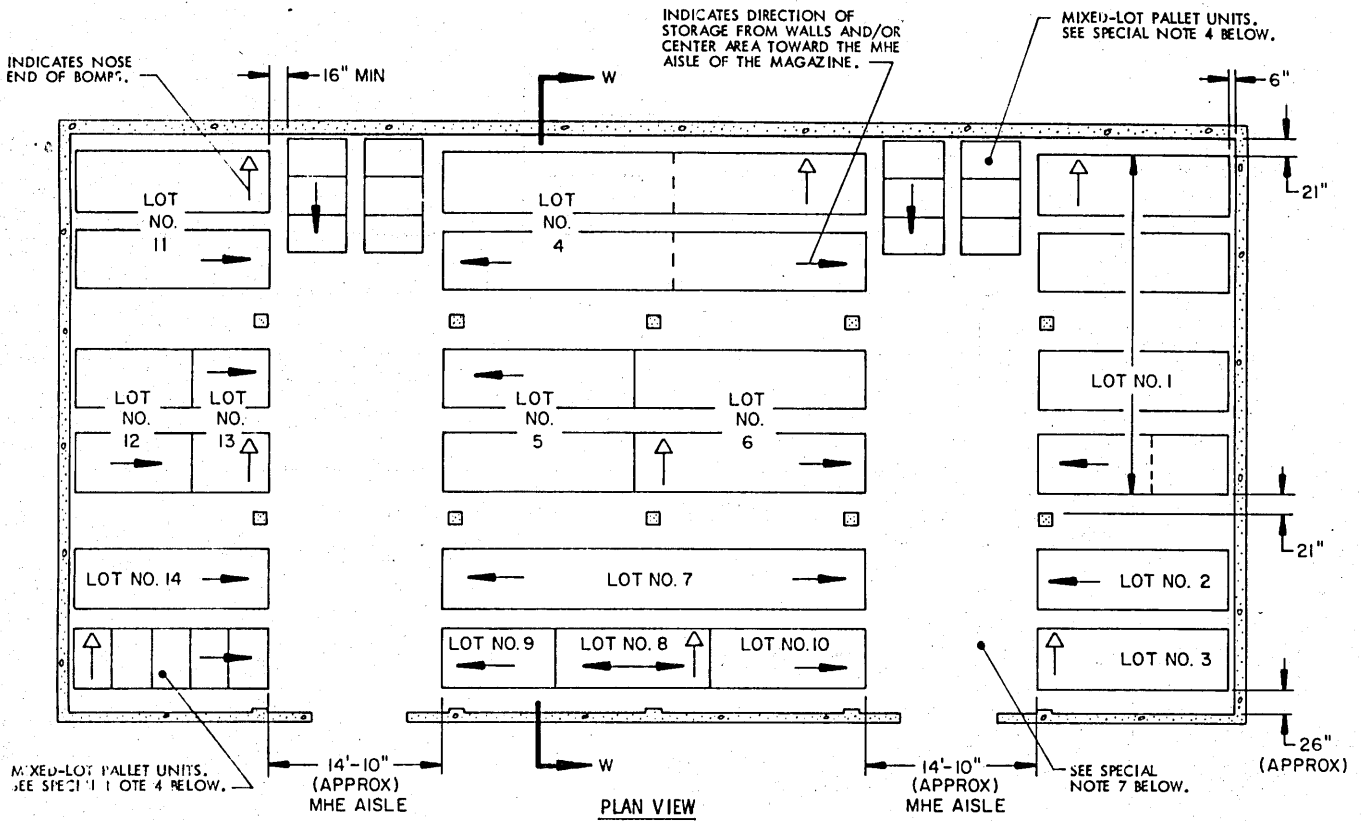

SPECIAL NOTES:

1. THE STORAGE PLANS AND CONFIGURATIONS SHOWN ARE TYPICAL ONLY. ADAPTATIONS MAY BE MADE AS NUMBER AND SIZES OF LOTS TO BE STORED IN MAGAZINE REQUIRE.
2. AN INSPECTION AISLE NOT LESS THAN 16" WIDE MUST BE PROVIDED AT THE NOSE END AND AT THE BASE END OF THE BOMBS.
3. GENERALLY, THE LARGEST LOT SHOULD BE STORED IN THE REAR OR ON ONE SIDE OF THE MAGAZINE. HOWEVER, THESE AREAS MAY BE USED TO STORE MORE THAN ONE LOT BY ERECTING ROWS SIMILAR TO THOSE SHOWN ON THE LEFT SIDE AND IN THE CENTER AREA OR AS TYPICALLY INDICATED BY DOTTED LINES. EACH ADDITIONAL LOT MUST BE ACCESSIBLE FOR REMOVAL AND INSPECTION/INVENTORY IN ACCORDANCE WITH OTHER CRITERIA SPECIFIED IN THESE SPECIAL NOTES AND IN THE GENERAL NOTES ON PAGE 2.
4. A MIXED-LOT PALLET UNIT MAY HAVE FROM TWO LOTS PER PALLET UNIT UPWARDS TO AS MANY DIFFERENT LOTS AS BOMBS WITHIN THAT UNIT. HOWEVER, ALL BOMBS AND LOTS WITHIN THE PALLET UNIT MUST HAVE THE SAME NATIONAL STOCK NUMBER AND CONDITION CODE.
5. EACH LOT WITHIN THE MAGAZINE MUST BE ACCESSIBLE FOR MOVEMENT BY MHE. PALLET UNITS OF A SINGLE-LOT OR MIXED-LOT PALLET UNITS ARE CONSIDERED "ACCESSIBLE" IF NO MORE THAN TWENTY-FOUR (24) "LIFTS" OF ANOTHER LOT OR LOTS HAVE TO BE MADE TO GAIN ACCESS TO THE SINGLE-LOT OR MIXED-LOT UNITS. A "LIFT" MAY CONSIST OF ONE (1) OR MORE PALLET UNITS, PROVIDING THE CAPACITY OF MHE PERMITS, AND SAFE HANDLING IS NOT JEOPARDIZED.

(CONTINUED AT RIGHT)

(SPECIAL NOTES CONTINUED)

6. WHEN TWO LOTS ARE STORED ADJACENT TO EACH OTHER, WITH UNITS OF ONE LOT HAVING BOMBS PARALLEL TO AND SIDE BY SIDE WITH THE BOMBS IN THE OTHER LOT, THEY SHOULD BE SEPARATED BY AT LEAST 1" TO PROVIDE CLEARANCE FOR REMOVAL OF EITHER LOT.
7. THE MHE AISLE MAY BE USED TO STORE ONE OR MORE STACKS OF ADDITIONAL LOTS OR ADDITIONAL ITEMS THAT ARE FROM A LOT ADJACENT TO THE MHE AISLE. THIS ADDITIONAL STORAGE IS TO BE ARRANGED IN A MANNER SIMILAR TO ARRANGEMENTS DEPICTED ON PAGES 17 AND 19 FOR THE "ADDITIONAL STORAGE LOCATIONS" (SHOWN BY DOTTED LINES). ADEQUATE SPACE FOR MHE OPERATION, AS DESCRIBED ON PAGES 17 AND 19, MUST BE MADE AVAILABLE FOR THE ADDITIONAL STORAGE. ALSO, COMPLIANCE WITH ALL OF THE MULTIPLE-LOT CRITERIA AS SET FORTH ON THIS PAGE MUST BE OBSERVED.