

STORAGE IN APPROVED MAGAZINES OF 175 MM SEPARATE LOADING PROJECTILES, UNITIZED 12 ROUNDS PER 41-1/4" L X 53" W X 22-3/4" H PALLET UNIT

INDEX

<u>ITEM</u>	<u>PAGE (S)</u>
GENERAL NOTES, AND MATERIAL SPECIFICATIONS -----	2
DETAILS -----	3
STORAGE PROCEDURES (EARTH-COVERED MAGAZINES):	
80', 60' AND 40' L X 26'-6" W X 12'-9" H IGLOO MAGAZINES -----	4, 5
80' AND 40' L X 25' W X 10' H ARCH TYPE MAGAZINES (IGLOO) -----	6, 7
80' AND 40' L X 25' W X 11' H ARCH TYPE MAGAZINES (IGLOO) -----	8, 9
80' AND 40' L X 25' W X 12'-1-3/4" H ARCH TYPE MAGAZINES (IGLOO) -----	10, 11
81'-2" L X 26'-6" W X 12'-1-3/4" H ARCH TYPE MAGAZINE (IGLOO) -----	12, 13
80' L X 25' W X 14'-4" H STRADLEY AND 89' L X 24'-10" W X 14'-4" H OVAL ARCH MAGAZINES -----	14, 15
52' DIA CORBETTA MAGAZINE -----	16, 17
100' L X 50' W RECTANGULAR MAGAZINE -----	18, 19
TYPICAL MULTIPLE-LOT STORAGE PROCEDURES:	
IGLOO AND ARCH TYPE MAGAZINES -----	20, 21
STRADLEY AND OVAL ARCH TYPE MAGAZINES -----	22, 23
CORBETTA MAGAZINE -----	24, 25
RECTANGULAR MAGAZINE -----	26

● HEIGHT OF UNIT MAY VARY SLIGHTLY, HOWEVER
PROCEDURES SPECIFIED HEREIN WILL APPLY.

DO NOT SCALE

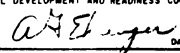
REVISIONS				DRAFTSMAN	CHKD ENG
				DAK	RWS
				CHECKER	LOG ENGRG OFFICE
				RSM/RSB	
APPROVED, U. S. ARMY ARMAMENT MATERIEL READINESS COMMAND					
APPROVED BY ORDER OF COMMANDING GENERAL, U. S. ARMY MATERIEL DEVELOPMENT AND READINESS COMMAND (DARCOM)					
 DARCOM AMMO CENTER					
U. S. ARMY DARCOM DRAWING					
DECEMBER 1978					
CLASS	DIVISION	DRAWING	FILE		
19	48	4102/4	1-3-4-14 22PE1001		

GENERAL NOTES

(GENERAL NOTES CONTINUED)

- A. THIS DOCUMENT HAS BEEN PREPARED AND ISSUED IN ACCORDANCE WITH AR 740-1, AND AUGMENTS TM 743-200-1 (CHAPTER 5).
- B. THE STORAGE PROCEDURES DEPICTED WITHIN THIS DOCUMENT ARE APPLICABLE FOR STORAGE IN VARIOUS TYPES AND SIZES OF MAGAZINES. THE STORAGE PROCEDURES DEPICTED FOR THE SPECIFIC TYPES OF MAGAZINES MAY ALSO BE UTILIZED TO STORE PROJECTILE PALLET UNITS IN OTHER TYPES OF APPROVED MAGAZINES. MINOR ADJUSTMENTS MAY BE MADE TO FACILITATE STORAGE IN OTHER TYPES OF MAGAZINES, HOWEVER, THE BASIC PRINCIPLES AS DEPICTED HEREIN WILL BE FOLLOWED.
- C. CAUTION: THE ALLOWABLE "EXPLOSIVE LIMIT" ESTABLISHED FOR A MAGAZINE IS NOT TO BE EXCEEDED. STORAGE OF SOME SPECIFIC TYPES OF SEPARATE LOADING PROJECTILES MUST ALSO COMPLY WITH CURRENT DIRECTIVE AND REGULATORY REQUIREMENTS OTHER THAN AS SPECIFIED IN THIS DRAWING.
- D. STORED PALLET UNITS MUST NOT CONTACT THE WALLS OF A MAGAZINE. TO PROVIDE FOR THIS MANDATORY CLEARANCE REQUIREMENT, UNITS MAY BE ELIMINATED FROM THE DEPICTED STORAGE PATTERN AS NECESSARY.
- E. AISLE DIMENSIONS SHOWN FOR STORAGE PROCEDURES IN MAGAZINES MAY BE ADJUSTED TO SUIT LOCAL CONDITIONS, VARIATIONS IN PALLET UNIT DIMENSIONS, AND/OR AVAILABLE MATERIALS HANDLING EQUIPMENT.
- F. THE MAXIMUM FLOOR LOAD FOR A MAGAZINE AS PRESCRIBED BY LOCAL STANDARDS WILL NOT BE EXCEEDED.
- G. IF AVAILABLE MHE PERMITS, ADDITIONAL PALLETIZED UNITS MAY BE STORED WITHIN THE FRONTAL AREA AND/OR OTHER AVAILABLE AREA OF THE MAGAZINE.
- H. THE HEIGHT OF THE PACKAGE GUARD ON SOME FORKLIFT TRUCKS MAY NOT PERMIT PLACEMENT OF SOME TOP LAYER UNITS IN THE STACKS SHOWN IN THE STORAGE VIEWS HEREIN, UNLESS TWO UPPER PALLET UNITS ARE HANDLED AS ONE LIFT OR THE PACKAGE GUARD IS REMOVED (TINE CARRIAGE WILL IN MOST INSTANCES PROVIDE ADEQUATE PACKAGE GUARD PROTECTION). ONLY A FORKLIFT TRUCK OF ADEQUATE CAPACITY WILL BE USED WHEN LIFTING TWO PALLET UNITS AS ONE LIFT.
- J. STACK-STABILIZING DUNNAGE IN THE FORM OF "SHIMS" PROBABLY WILL BE REQUIRED TO ACHIEVE SOUND AND ACCEPTABLE STABLE STACKS. SHIM MATERIAL OF VARYING THICKNESSES WILL BE USED AS REQUIRED TO GAIN LEVEL OR NEARLY LEVEL STACKS AND SOLID BEARING WITHIN A STACK FROM THE FLOOR OF A MAGAZINE TO THE TOP OF THE STACK.
- K. THE USE OF "FLOOR DUNNAGE" UNDER METAL PALLETS IS OPTIONAL, ALTHOUGH THE USE OF THIS TYPE OF DUNNAGE IS DELINEATED WITHIN THIS STORAGE PROCEDURE DRAWING. THE PURPOSE OF FLOOR DUNNAGE IS TO HELP KEEP THE RUNNERS OF A PALLET DRY, THUS AIDING IN PREVENTING DETERIORATION DUE TO OXIDATION (RUSTING). THEREFORE, FLOOR DUNNAGE SHOULD BE USED WHEN STORING IN A MAGAZINE THAT IS KNOWN TO HAVE A "DAMP" FLOOR. ALSO, IN LIEU OF USING ONE-INCH THICK FLOOR DUNNAGE AS SPECIFIED, THE USE OF THICKER FLOOR DUNNAGE MAY BE REQUIRED, AND SHOULD BE USED, TO ACHIEVE THE DESIRED OBJECTIVE.
- L. DUNNAGE LUMBER SPECIFIED THROUGHOUT THIS PROCEDURAL DRAWING IS OF NOMINAL SIZE. FOR EXAMPLE, 1" X 6" MATERIAL IS ACTUALLY 3/4" THICK BY 5-1/2" WIDE.
- M. PORTIONS OF THE MAGAZINES, SUCH AS SIDEWALLS, END WALLS, AND ROOFS, HAVE NOT BEEN SHOWN IN THE STORAGE VIEWS FOR CLARITY PURPOSES.
- N. STORAGE OF MULTIPLE LOTS IN A MAGAZINE WILL REQUIRE CAREFUL PREPLANNING SO AS TO INSURE MHE ACCESSIBILITY TO ANY LOT IN ACCORDANCE WITH REQUIREMENTS SET FORTH IN THE APPLICABLE "SPECIAL NOTES" SECTIONS OF THE MULTIPLE-LOT STORAGE PROCEDURES TYPICALLY SHOWN ON PAGES 20 THRU 26.
- O. ALTHOUGH SPECIFIC PROCEDURES ARE INCLUDED IN THIS DRAWING FOR STORING MULTIPLE LOTS WITHIN ONE STRUCTURE, THE BASIC STORAGE PATTERNS AS SHOWN ON PAGES 4 THRU 19 CAN ALSO BE ADAPTED FOR THE STORING OF MORE THAN ONE LOT. LOTS WHEN STORED IN ACCORDANCE WITH A BASIC STORAGE PATTERN MAY BE STORED WITH ONE OR MORE ROWS USED FOR EACH LOT. A SPACE OF APPROXIMATELY 1" WILL HAVE TO BE LEFT BETWEEN ADJACENT ROWS CONTAINING DIFFERENT LOTS. IN BASIC STORAGE PATTERNS WHERE THE WIDTH OF A ROW IS ESTABLISHED BY THE 53" UNIT-DIMENSION, EACH ROW MAY BE A DIFFERENT LOT AND BE READILY REMOVABLE. IN BASIC STORAGE PATTERNS WHERE THE WIDTH OF A ROW IS ESTABLISHED BY THE 41-1/4" UNIT-DIMENSION, A LOT MUST CONSIST OF TWO OR MORE ROWS TO PROVIDE ADEQUATE SPACE TO ACCOMMODATE THE WIDTH OF A FORKLIFT TRUCK FOR STORING OR REMOVING THE LOT. HOWEVER, WHEN THE SIZE OF A LOT REQUIRES THE SPACE OF ONLY ONE ROW, IT IS PERMISSIBLE TO STORE THAT LOT WITH THE 5" UNIT-DIMENSION ESTABLISHING THE WIDTH OF THAT ROW, PROVIDING THE STORAGE PRINCIPLES SPECIFIED ARE FOLLOWED AS CLOSELY AS POSSIBLE. THE 1" SPACE BETWEEN LOTS, AS STATED ABOVE, WILL NOT BE EXCEEDED SOLELY TO ACCOMMODATE THE WIDTH OF A FORKLIFT TRUCK. FOR ADDITIONAL REQUIREMENTS AND GUIDANCE, SEE THE SPECIAL NOTES FOR MULTIPLE-LOT STORAGE ON PAGES 20 THRU 26.

(CONTINUED AT RIGHT)

MATERIAL SPECIFICATIONS

LUMBER ----- : SEE TM 743-200-1, DUNNAGE LUMBER, FED SPEC MM-L-751.

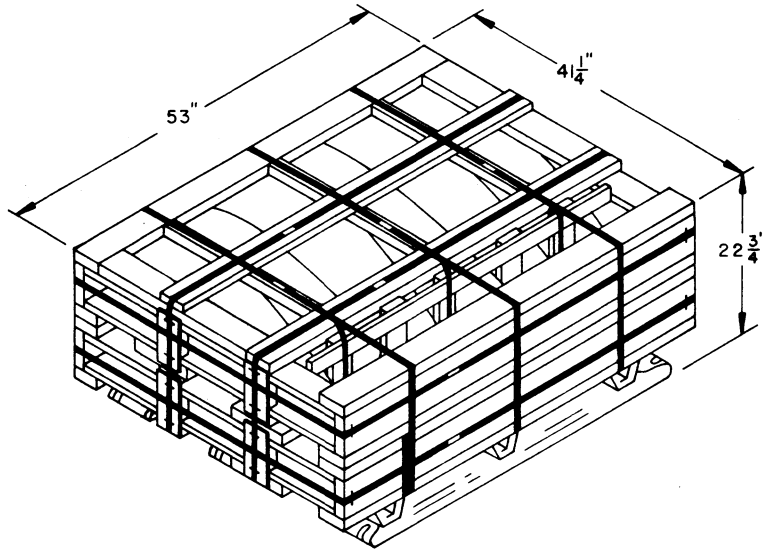

175MM, 12/PALLET

NOTE: SIZE OF UNIT MAY VARY SLIGHTLY.

UNIT WEIGHT ----- 2,022 LBS (APPROX)

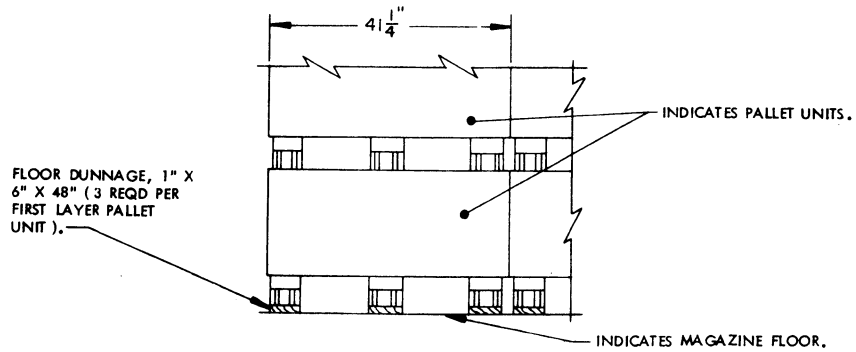

FLOOR DUNNAGE LOCATION DETAIL

ISOMETRIC VIEWS WITHIN THIS DRAWING DO NOT DEPICT ALL FLOOR DUNNAGE THAT IS REQUIRED WHEN FLOOR DUNNAGE IS USED. FLOOR DUNNAGE IS SHOWN AT SOME LOCATIONS TO PROVIDE POSITIONING GUIDANCE.

STORAGE IN 80' IGLOO

ITEM	QUANTITY
PALLET UNITS	493
PROJECTILES	5,910

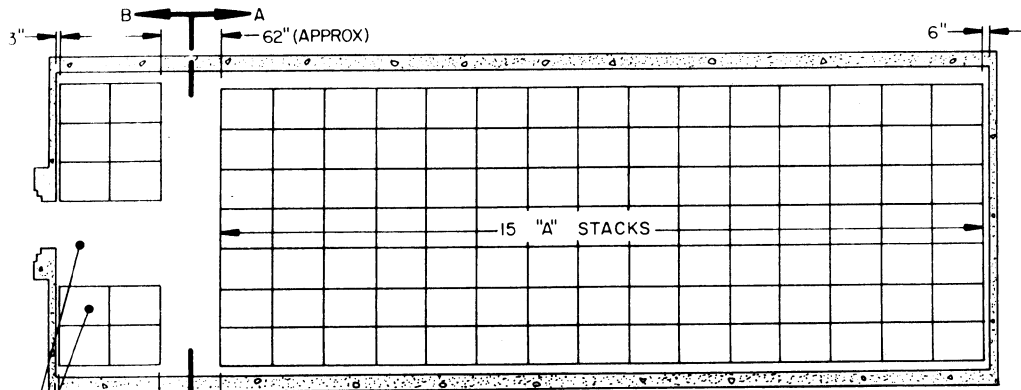

PLAN VIEW
(80' IGLOO)

SEE GENERAL NOTE "G" ON PAGE 2.

SEE GENERAL NOTE "D" ON PAGE 2.

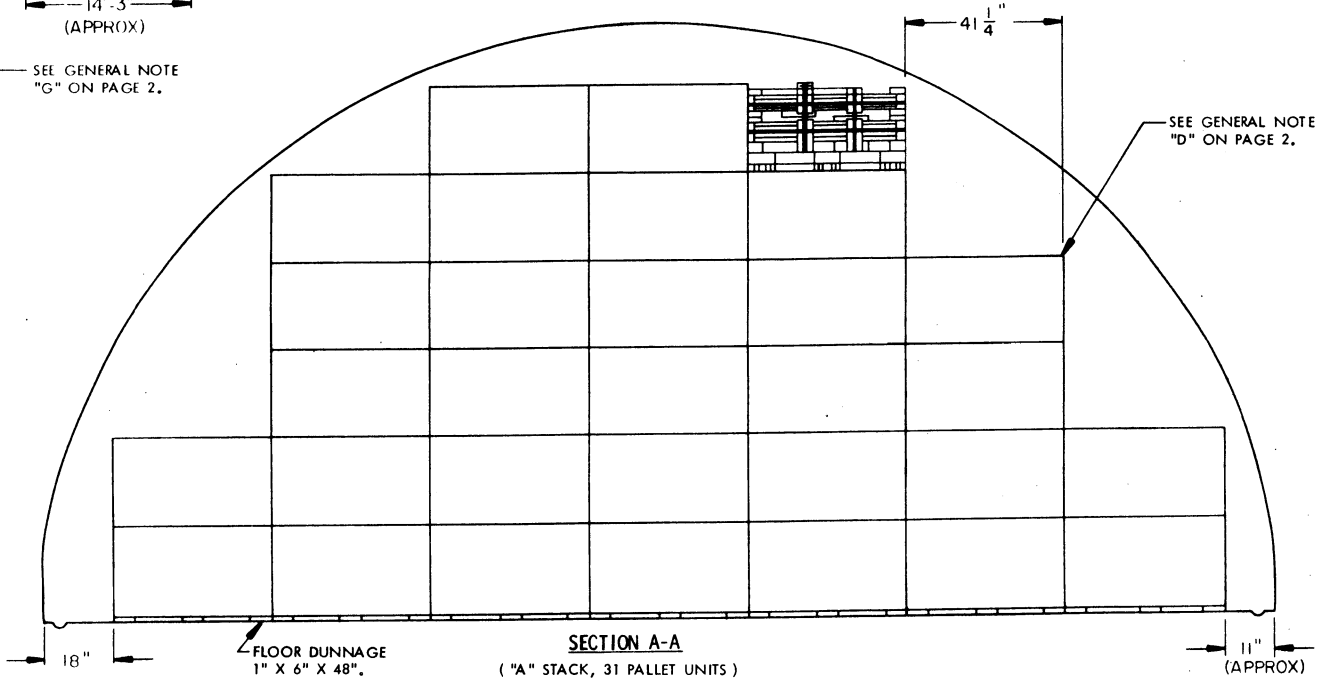

SECTION A-A
("A" STACK, 31 PALLET UNITS)

INDICATES OUTLINE OF DOOR OPENING.

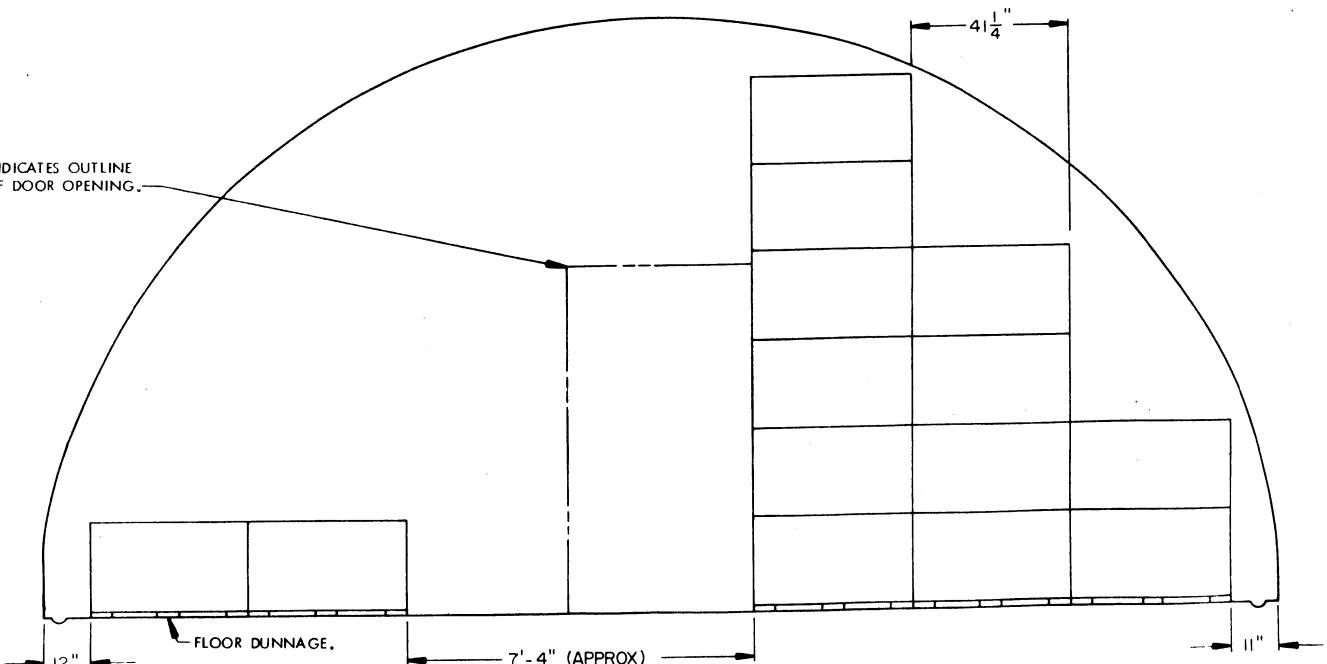

SECTION B-B ("C" STACK, 14 PALLET UNITS)

STORAGE PROCEDURES IN 80', 60' AND 40' L X 26'-6" W X 12'-9" H IGLOO MAGAZINES

STORAGE IN 60' IGLOO

ITEM	QUANTITY
PALLET UNITS -----	369
PROJECTILES -----	4,428

*** STORAGE IN 40' IGLOO**

ITEM	QUANTITY
PALLET UNITS -----	214
PROJECTILES -----	2,568

* 6 A-STACKS
2 C-STACKS

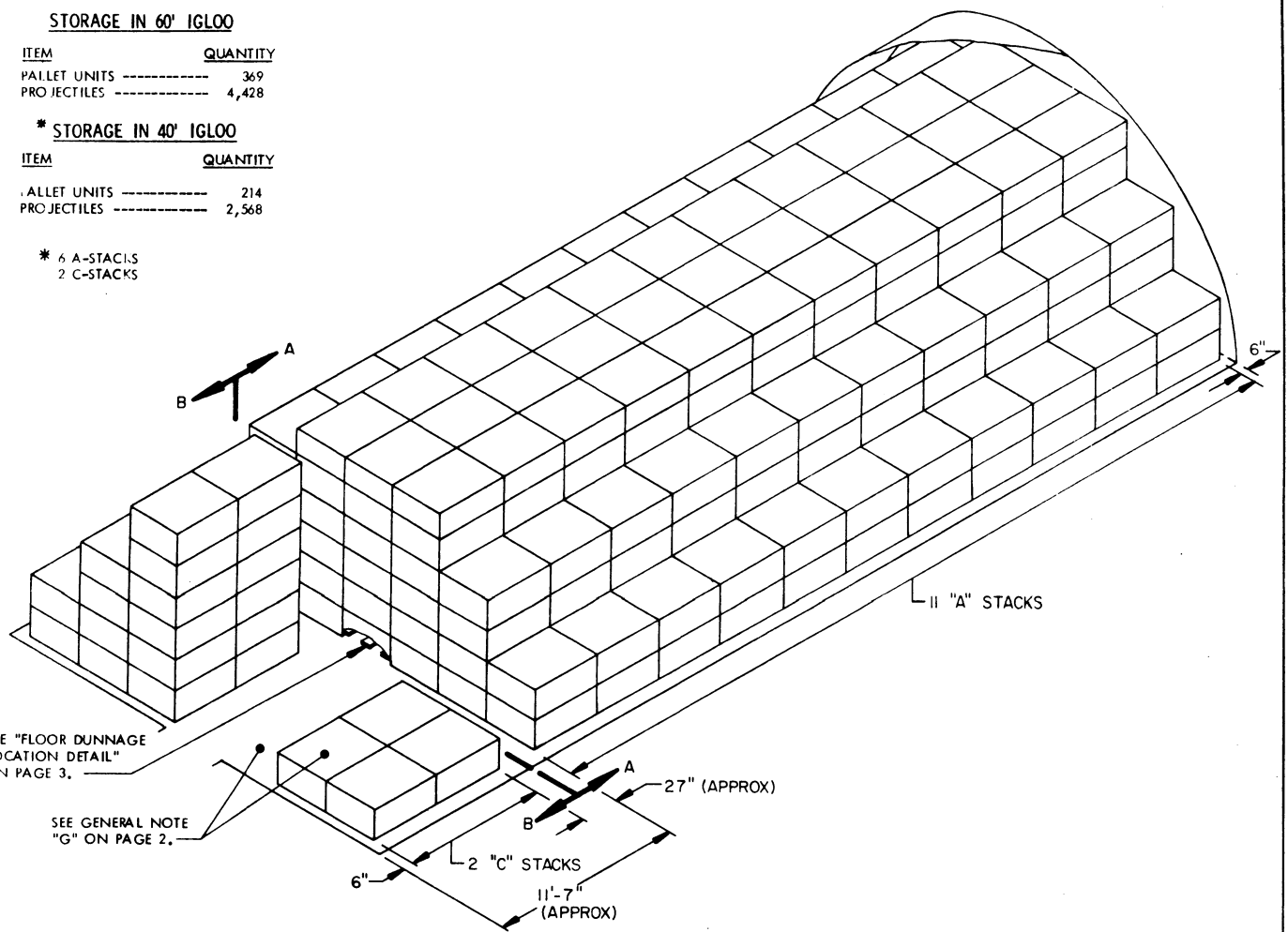

ISOMETRIC VIEW
(60' IGLOO)

FOR "GENERAL NOTES" AND "MATERIAL SPECIFICATIONS",
SEE PAGE 2.

SPECIAL NOTE:

MORE PALLET UNITS THAN SHOWN IN THE VIEWS ON PAGES 4 AND 5 CAN BE STORED IN A MAGAZINE, IF DESIRED AND IF THE MULTIPLE-LOT STORAGE CRITERIA OF GENERAL NOTE "O" ON PAGE 2 IS NOT USED. ONE ADDITIONAL PALLET UNIT CAN BE PLACED INTO THE THIRD LAYER OF EACH TYPE "A" STACK, TO PROVIDE CLEARANCE FOR AN ADDITIONAL UNIT IN A STACK, THE THIRD-LAYER PALLET UNITS ARE TO BE SHIFTED SIDEWARD ONE-HALF PALLET WIDTH, RELATIVE TO THE PALLET UNITS WITHIN THE SECOND LAYER.

BILL OF MATERIAL (PER STACK) * *		
TYPE STACK	1" X 6" DUNNAGE LUMBER	
	LINEAR FEET	BOARD FEET
A	84.00	42.00
C	60.00	30.00

* * SEE GENERAL NOTES "J" AND "K" ON PAGE 2.

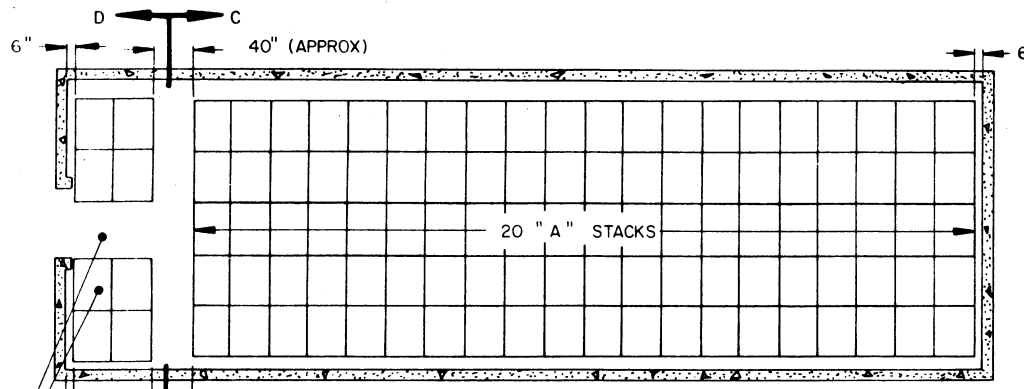

STORAGE IN 80' MAGAZINE
(10' HIGH)

ITEM	QUANTITY
PALLET UNITS	336
PROJECTILES	4,032

PLAN VIEW
(80' MAGAZINE)

SEE GENERAL NOTE "G" ON PAGE 2.

SEE GENERAL NOTE "D" ON PAGE 2.

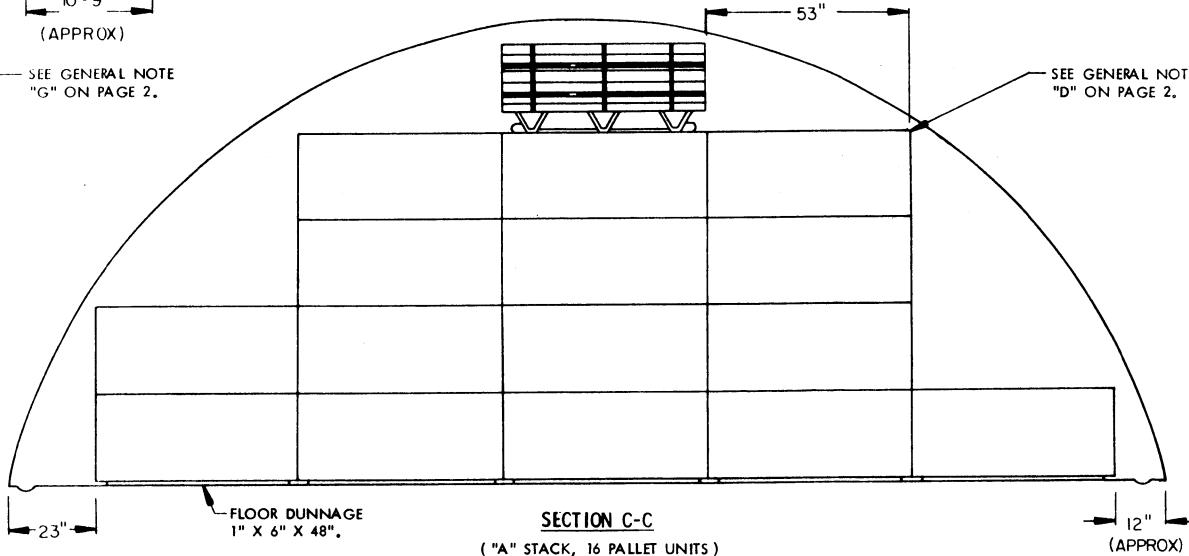

SECTION C-C
("A" STACK, 16 PALLET UNITS)

INDICATES OUTLINE OF DOOR OPENING.

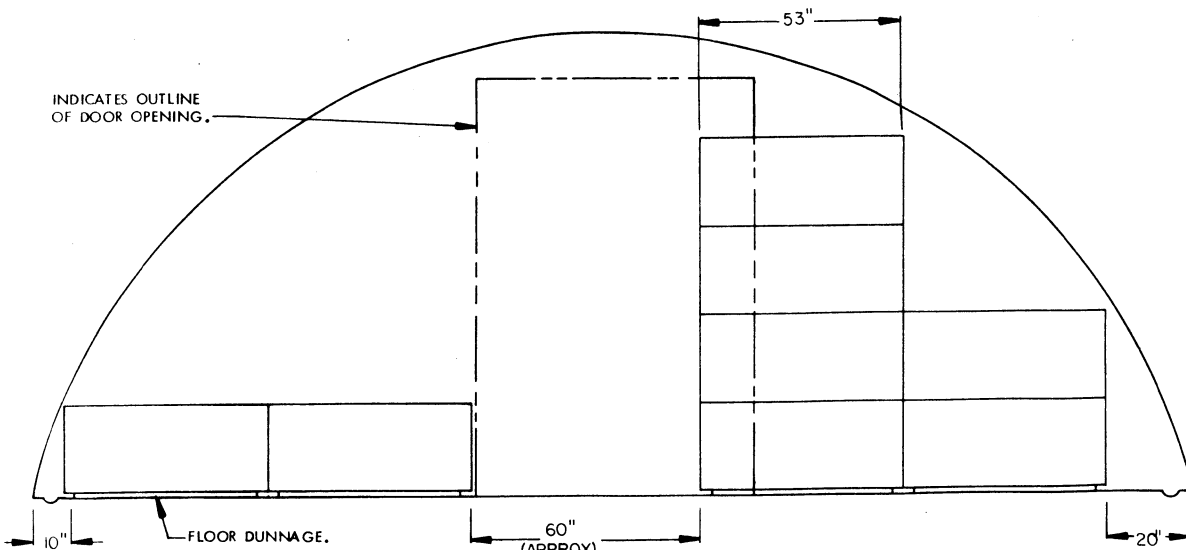

SECTION D-D
("C" STACK, 3 PALLET UNITS)

STORAGE IN 40' MAGAZINE

(10' HIGH)

ITEM	QUANTITY
PALLET UNITS-----	144
PROJECTILES-----	1,728

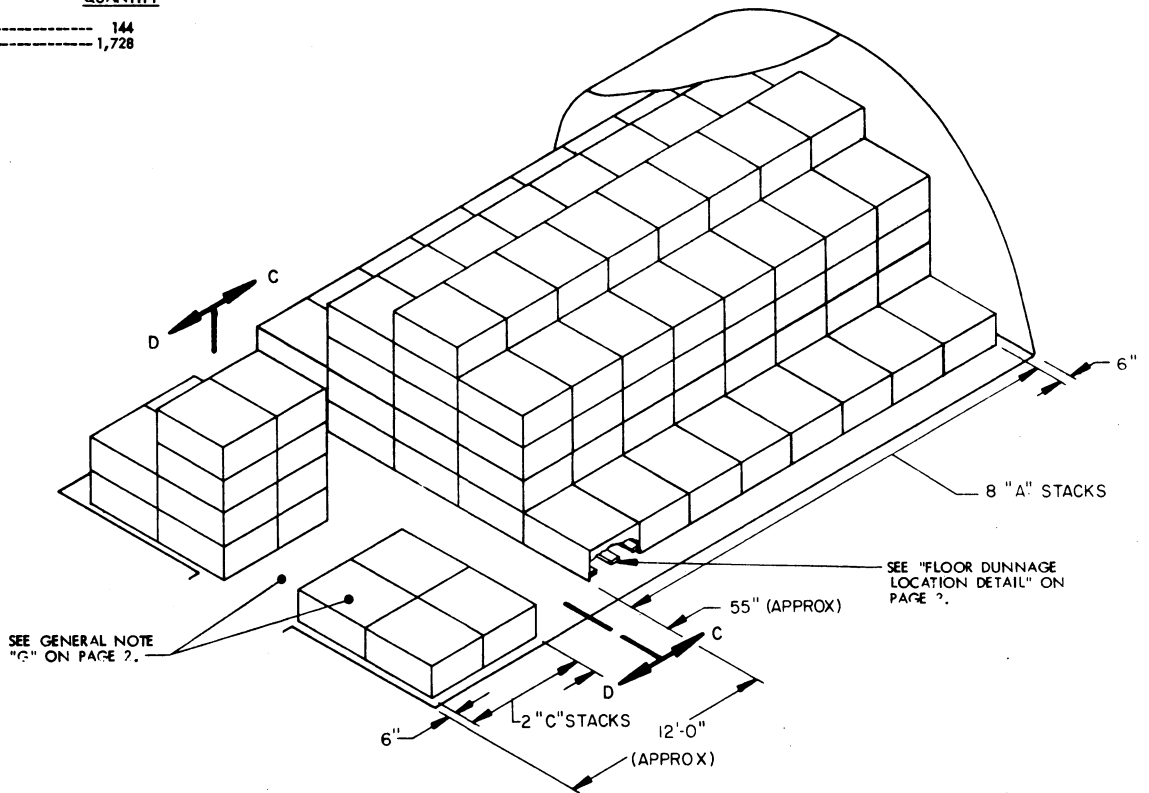

SEE GENERAL NOTE "C" ON PAGE 2.

SEE "FLOOR DUNNAGE LOCATION DETAIL" ON PAGE 2.

ISOMETRIC VIEW

(40' MAGAZINE)

FOR "GENERAL NOTES" AND "MATERIAL SPECIFICATIONS", SEE PAGE 2.

BILL OF MATERIAL (PER STACK) *		
TYPE STACK	1" X 6" DUNNAGE LUMBER	
	LINEAR FEET	BOARD FEET
A	60.00	30.00
C	48.00	24.00

* SEE GENERAL NOTES J AND "K" ON PAGE 2.

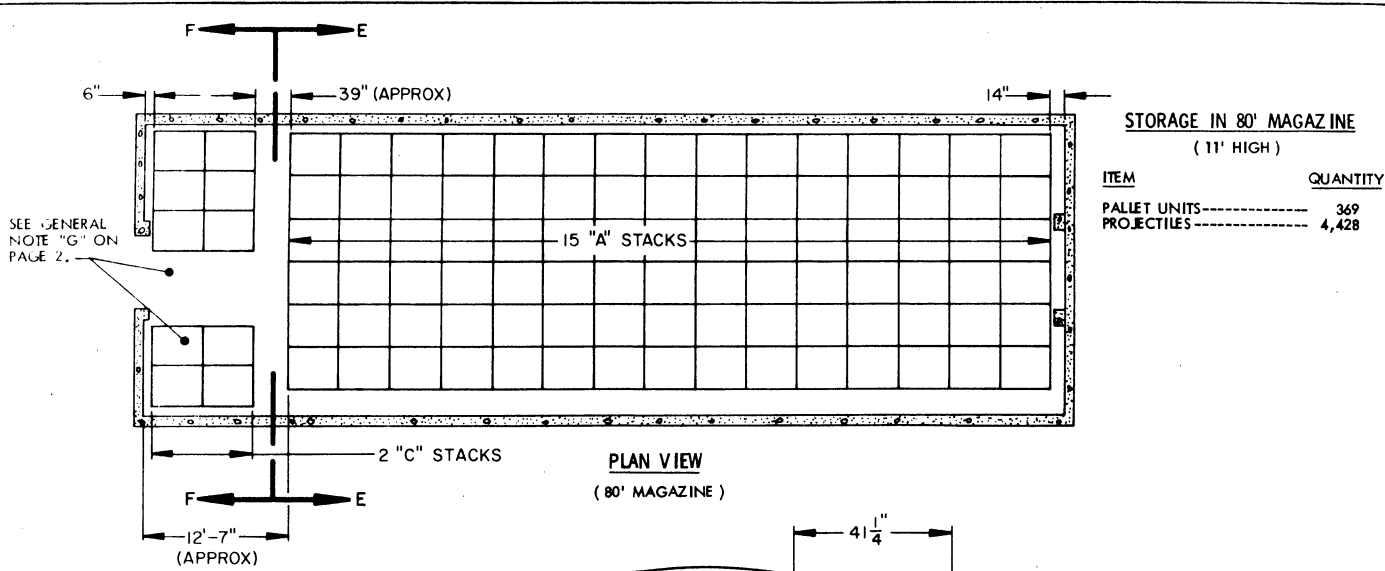

STORAGE IN 80' MAGAZINE
(11' HIGH)

ITEM	QUANTITY
PALLET UNITS-----	369
PROJECTILES-----	4,428

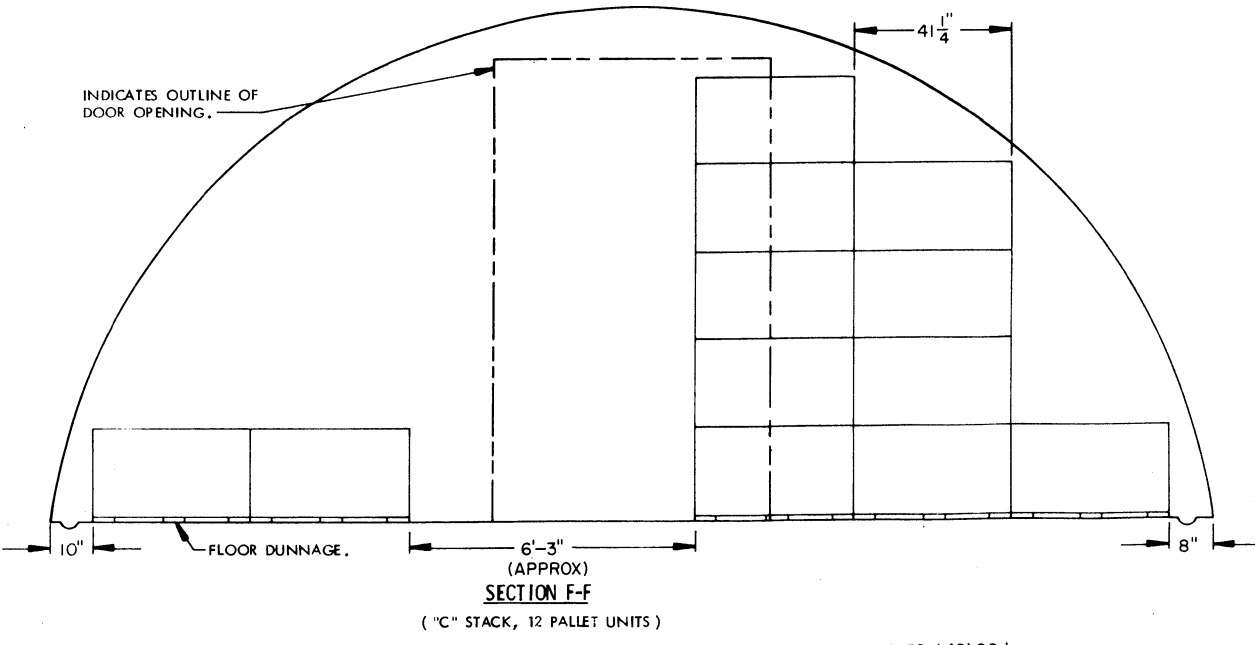
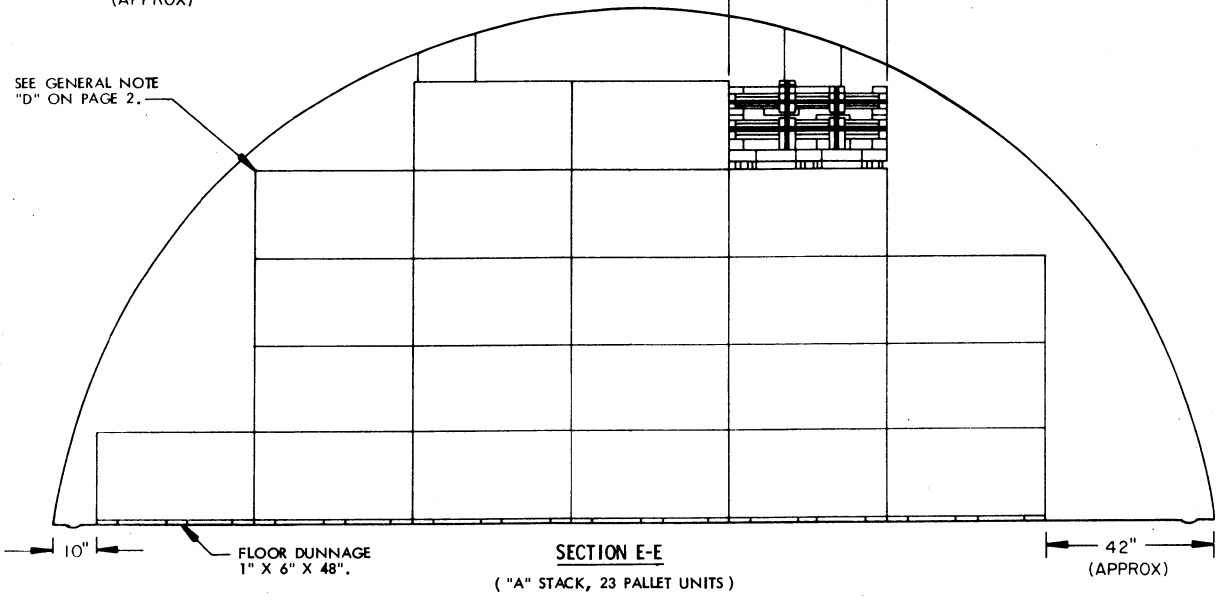

STORAGE IN 40' MAGAZINE

(11' HIGH)

ITEM	QUANTITY
PALLET UNITS-----	162
PROJECTILES-----	1,944

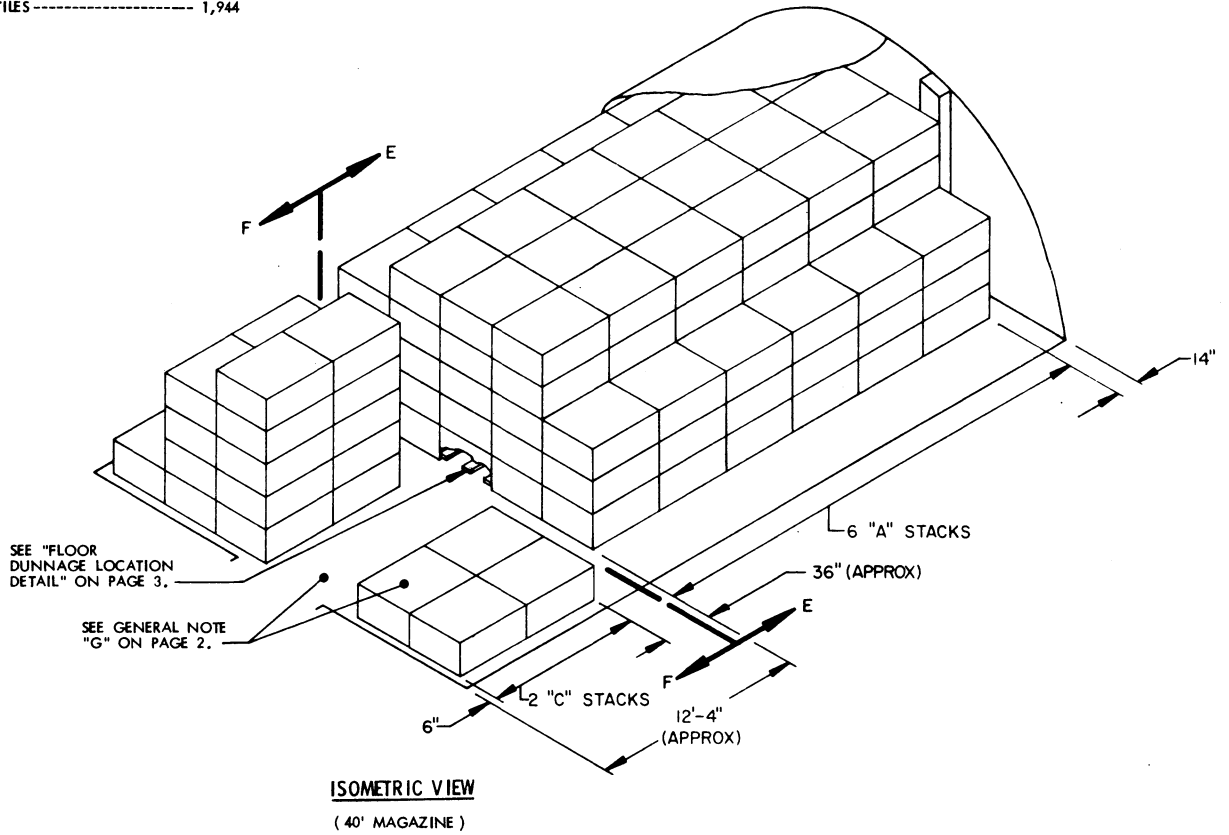

FOR "GENERAL NOTES" AND "MATERIAL SPECIFICATIONS" SEE PAGE 2.

BILL OF MATERIAL (PER STACK) *		
TYPE STACK	1" X 6" DUNNAGE LUMBER	
	LINEAR FEET	BOARD FEET
A	72.00	36.00
C	60.00	30.00

* SEE GENERAL NOTES "J" AND "K" ON PAGE 2.

STORAGE IN 80' MAGAZINE
(12' HIGH)

ITEM	QUANTITY
PALLET UNITS	450
PROJECTILES	5,400

SEE GENERAL NOTE "G" ON PAGE 2.

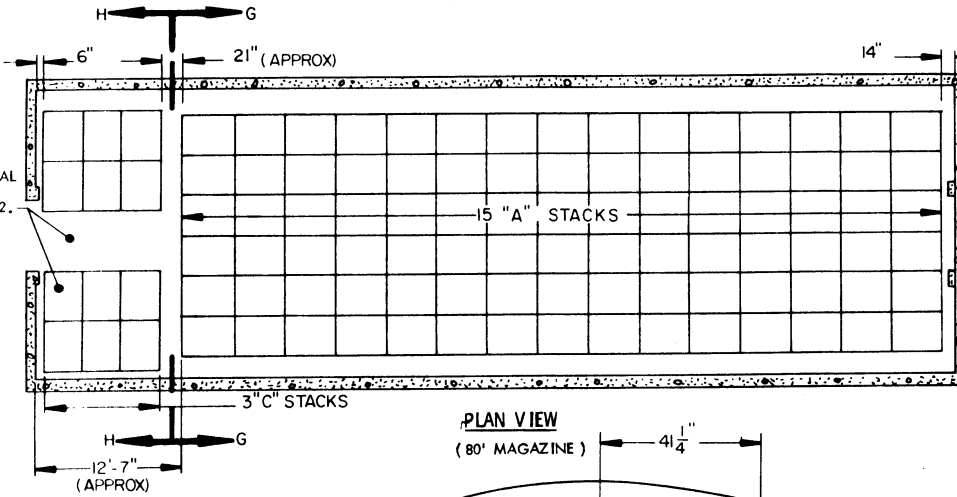

SEE GENERAL NOTE "D" ON PAGE 2.

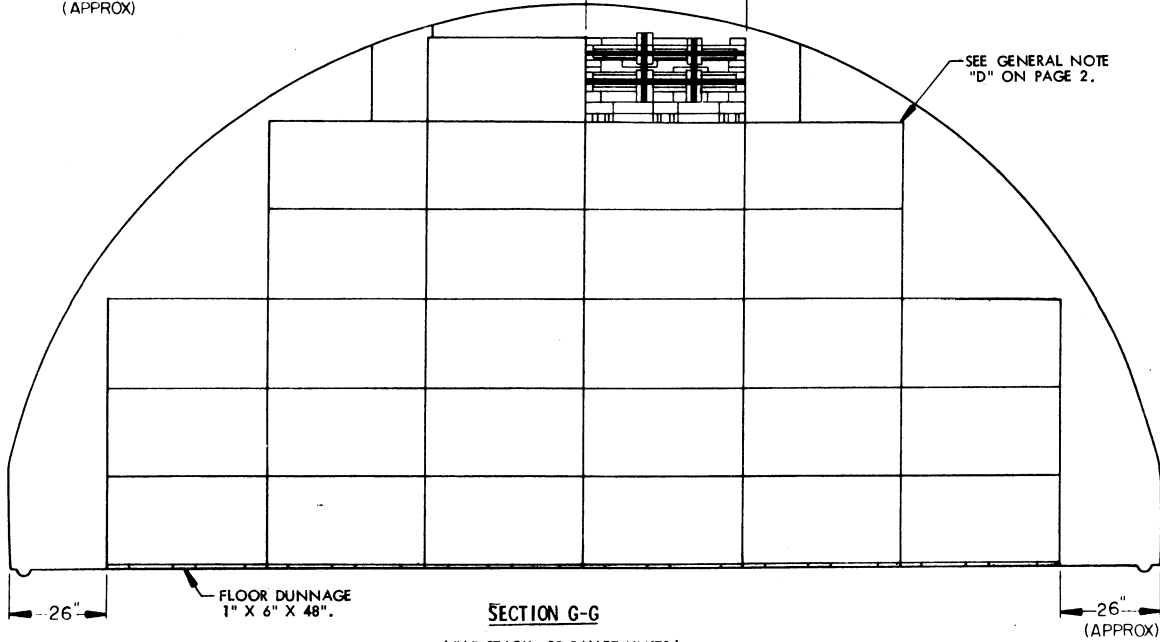

INDICATES OUTLINE OF DOOR OPENING.

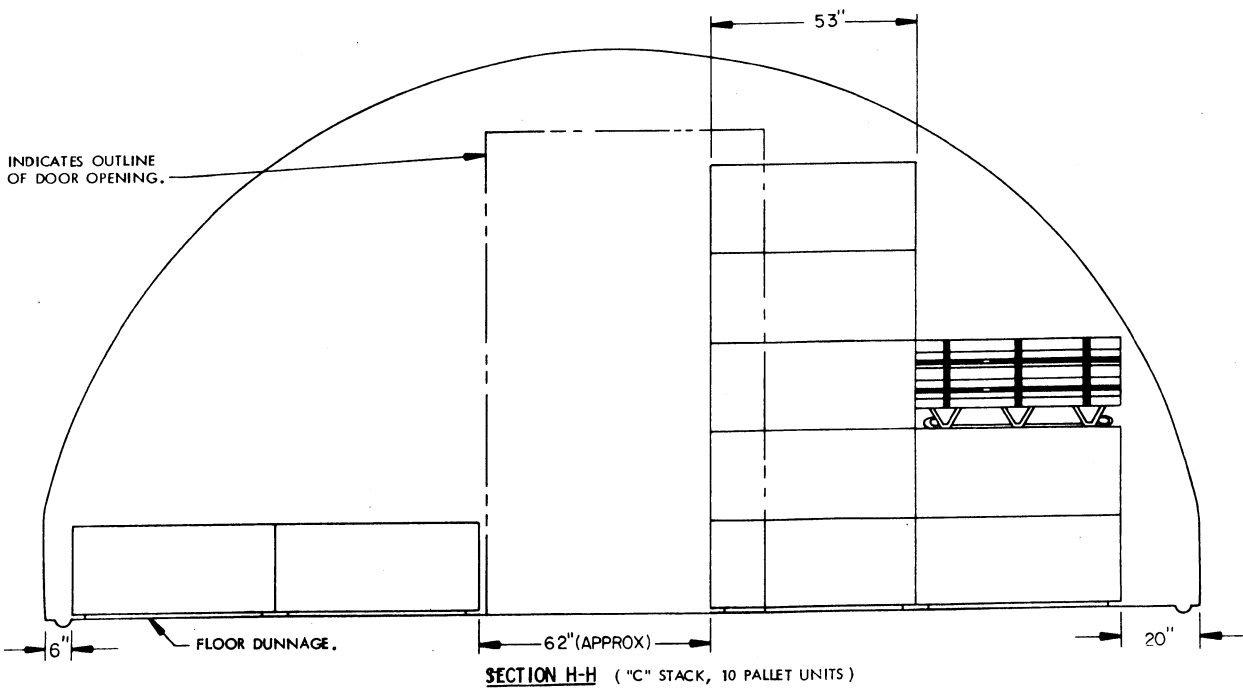

STORAGE PROCEDURES IN 80' AND 40' L X 25' W X 12'-1-3/4" H ARCH TYPE MAGAZINES (IGLOO)

STORAGE IN 40' MAGAZINE

(12' HIGH)

ITEM	QUANTITY
PALLET UNITS-----	198
PROJECTILES-----	2,376

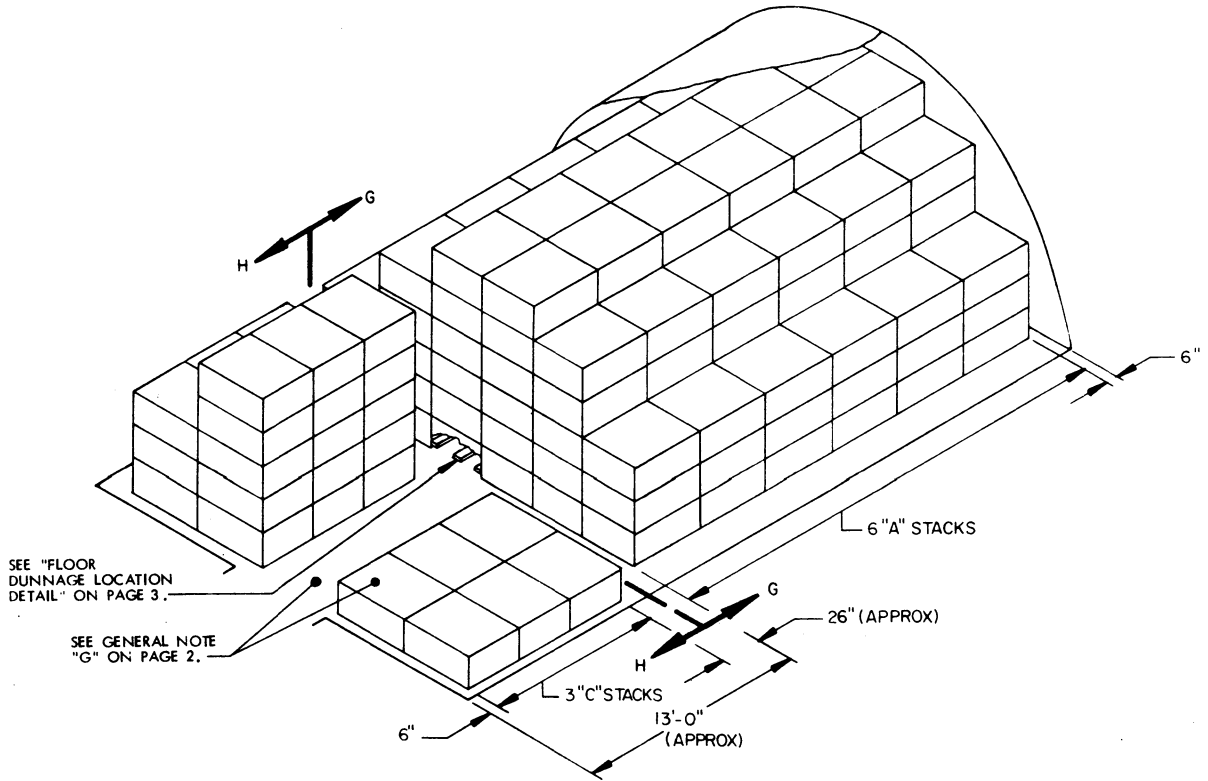

SEE "FLOOR DUNNAGE LOCATION DETAIL" ON PAGE 3.

SEE GENERAL NOTE "G" ON PAGE 2.

ISOMETRIC VIEW

(40' MAGAZINE)

FOR "GENERAL NOTES" AND "MATERIAL SPECIFICATIONS", SEE PAGE 2.

SPECIAL NOTE:

MORE PALLET UNITS THAN SHOWN IN THE STORAGE VIEWS ON PAGES 10 AND 11 CAN BE STORED IN A MAGAZINE, IF DESIRED AND IF THE MULTIPLE-LOT STORAGE CRITERIA OF GENERAL NOTE "O" ON PAGE 2 IS NOT USED. ONE ADDITIONAL PALLET UNIT CAN BE PLACED INTO THE FOURTH LAYER OF EACH TYPE "A" STACK TO PROVIDE CLEARANCE FOR AN ADDITIONAL UNIT IN A STACK. THE FOURTH LAYER PALLET UNITS ARE TO BE SHIFTED SIDEWARD ONE-HALF PALLET WIDTH, RELATIVE TO THE PALLET UNITS WITHIN THE THIRD LAYER.

'BILL OF MATERIAL (PER STACK) *

TYPE STACK	1" X 6" DUNNAGE LUMBER	
	LINEAR FEET	BOARD FEET
A	72.00	36.00
C	48.00	24.00

* SEE GENERAL NOTES "J" AND "K" ON PAGE 2.

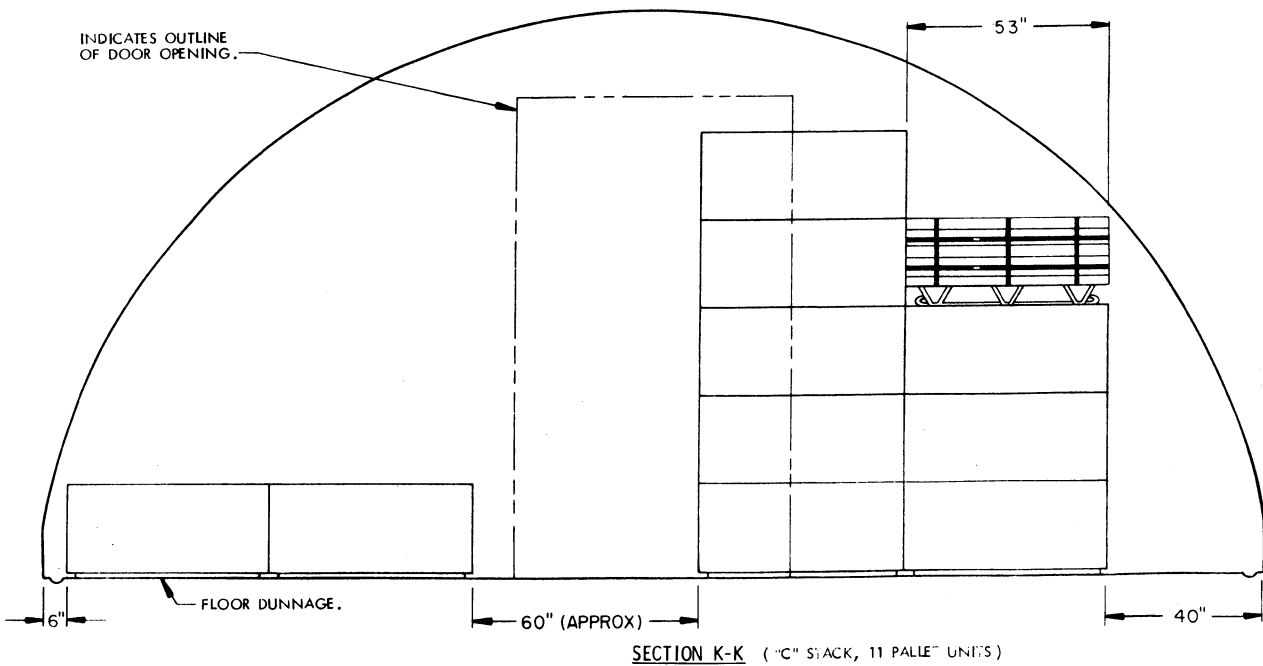
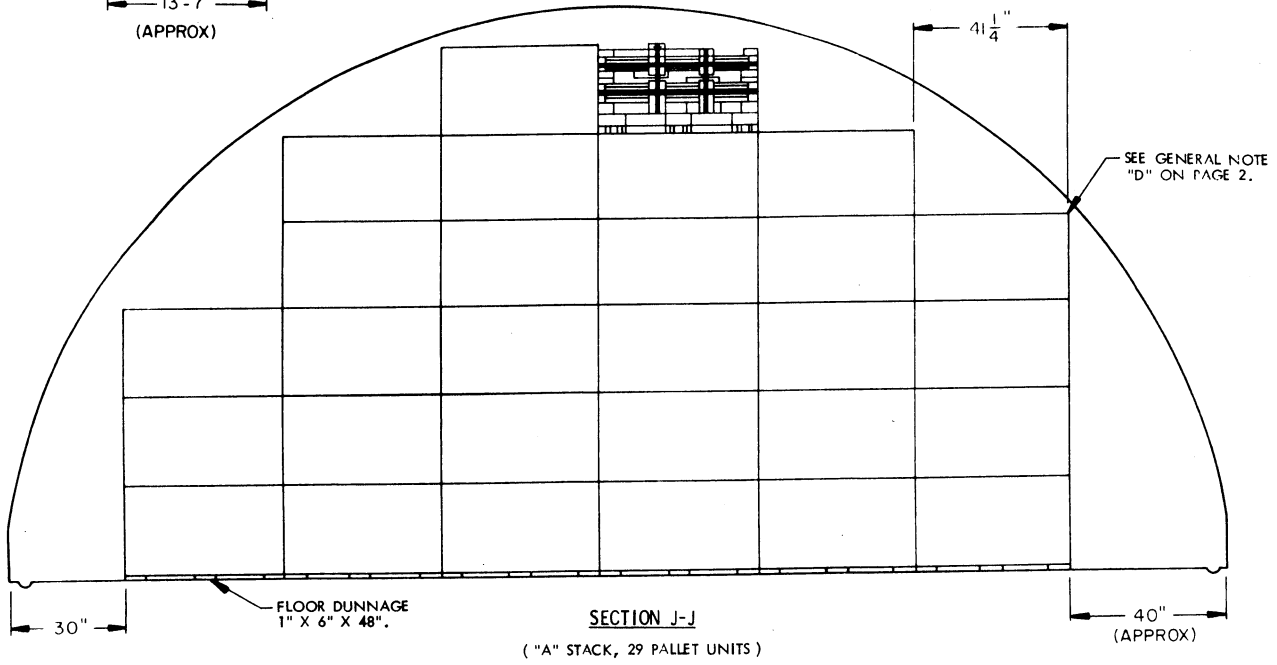
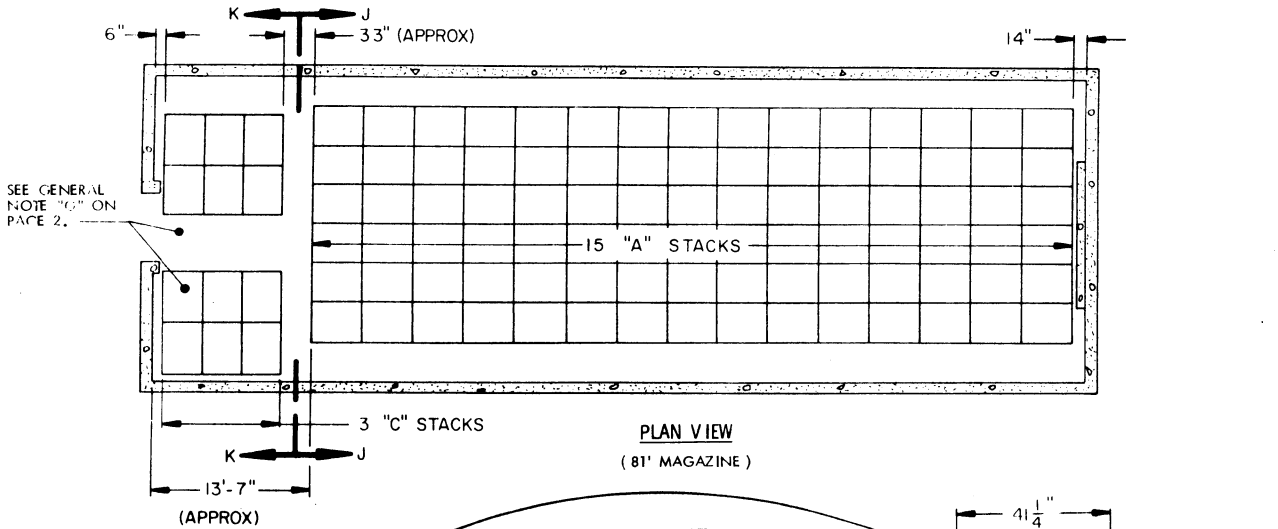

STORAGE IN 81' MAGAZINE

ITEM	QUANTITY
PALLET UNITS -----	468
PROJECTILES -----	5,616

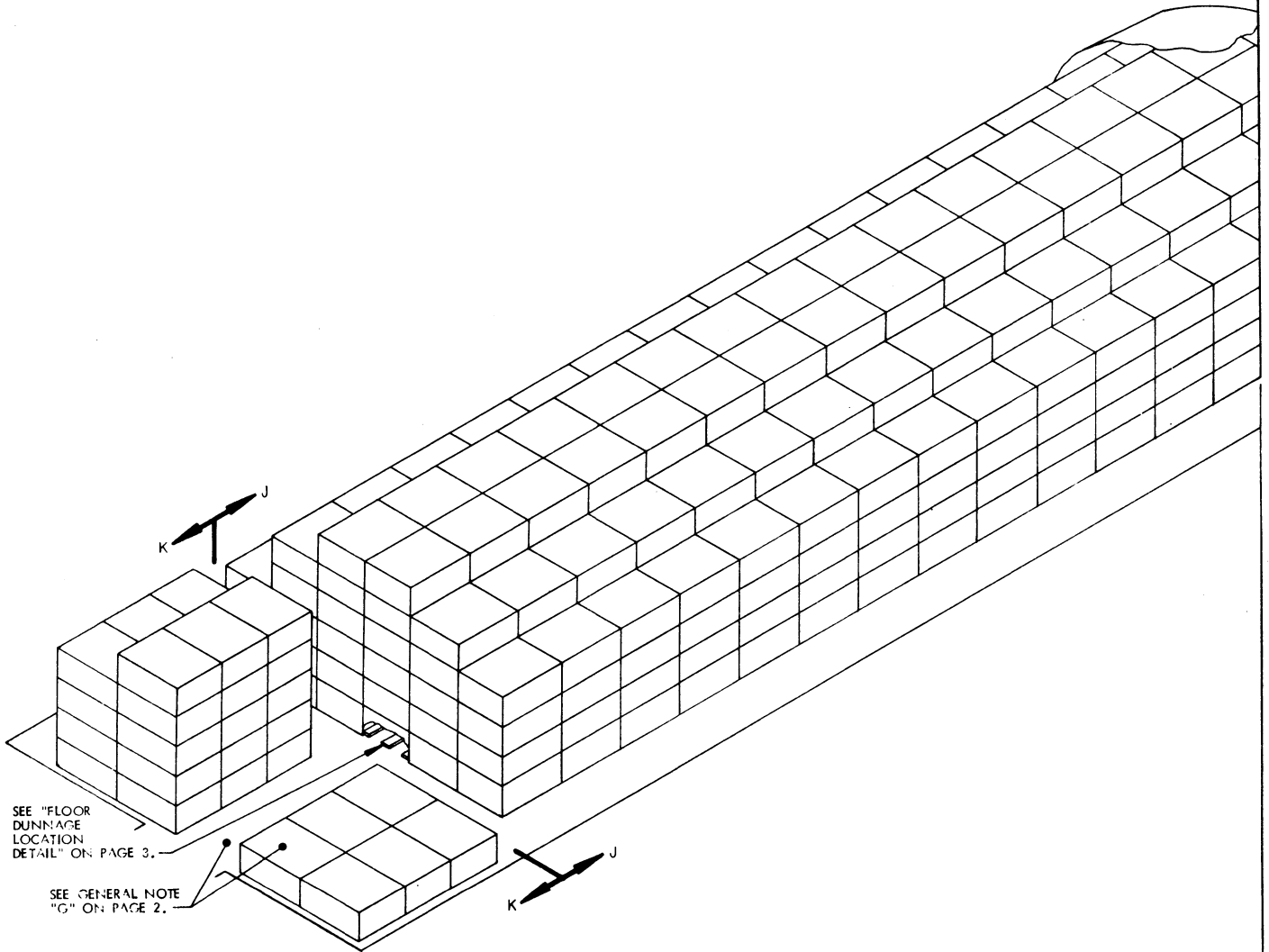

ISOMETRIC VIEW
(81' MAGAZINE)

**FOR "GENERAL NOTES" AND "MATERIAL SPECIFICATIONS",
SEE PAGE 2.**

BILL OF MATERIAL (PER STACK) *		
TYPE STACK	1" X 6" DUNNAGE LUMBER	
	LINEAR FEET	BOARD FEET
A	72.00	36.00
C	48.00	24.00

* SEE GENERAL NOTES "J" AND "K" ON PAGE 2.

SPECIAL NOTE:

MORE PALLET UNITS THAN SHOWN IN THE STORAGE VIEWS ON PAGES 12 AND 13 CAN BE STORED IN A MAGAZINE, IF DESIRED AND IF THE MULTIPLE-LOT STORAGE CRITERIA OF GENERAL NOTE "O" ON PAGE 2 IS NOT USED. ONE ADDITIONAL PALLET UNIT CAN BE PLACED INTO THE FIRST LAYER OF EACH TYPE "A" STACK, TO PROVIDE CLEARANCE FOR AN ADDITIONAL UNIT IN A STACK, THE FIRST-LAYER PALLET UNITS ARE TO BE SHIFTED SIDEWARD ONE-HALF PALLET WIDTH, RELATIVE TO THE PALLET UNITS WITHIN THE SECOND LAYER.

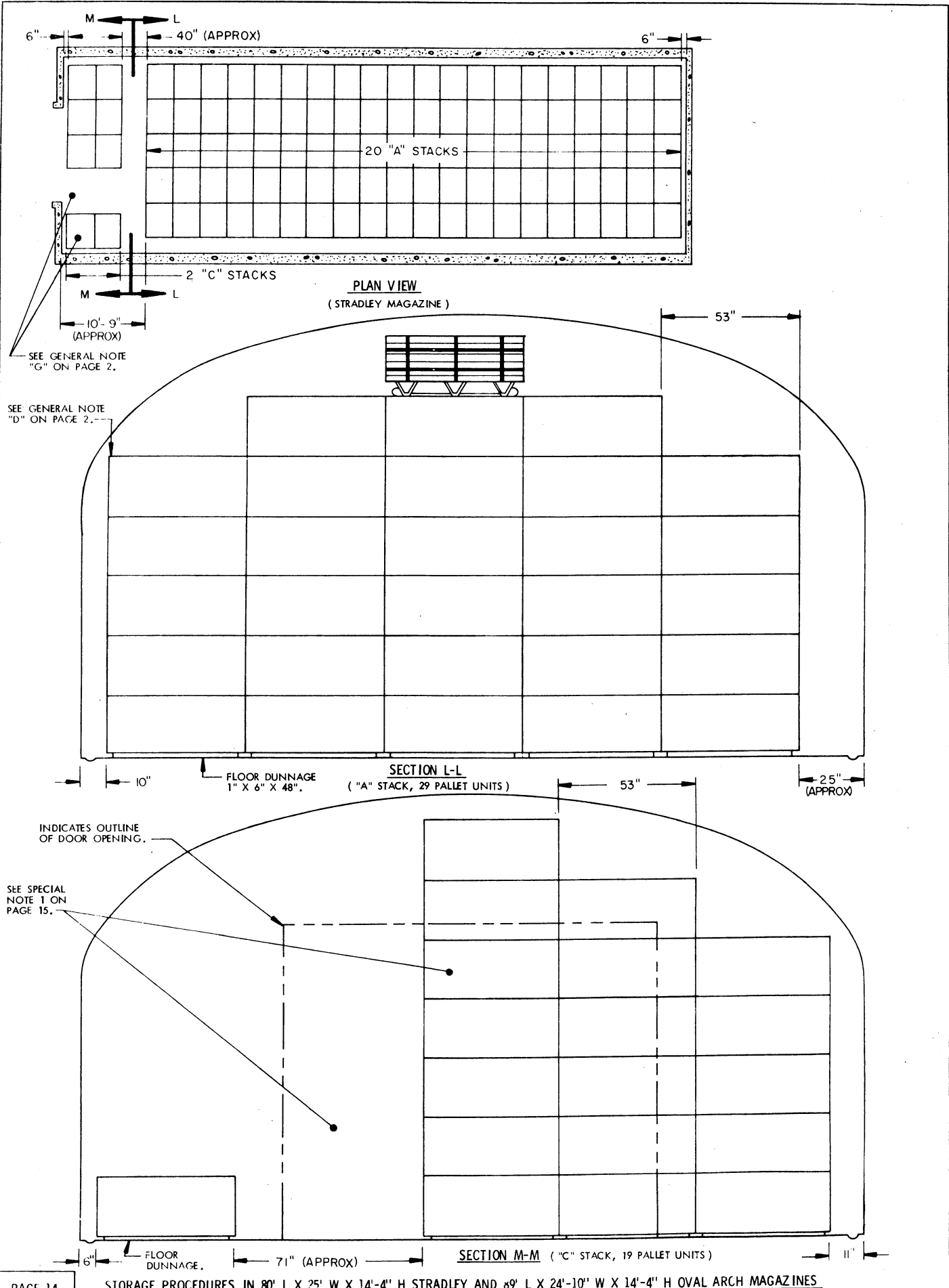

STORAGE IN STRADLEY MAGAZINE

ITEM	QUANTITY
PALLET UNITS -----	618
PROJECTILES -----	7,416

* STORAGE IN OVAL ARCH MAGAZINE
89' LONG

ITEM	QUANTITY
PALLET UNITS -----	677
PROJECTILES -----	8,124

- * 22 A-STACKS
3 C-STACKS

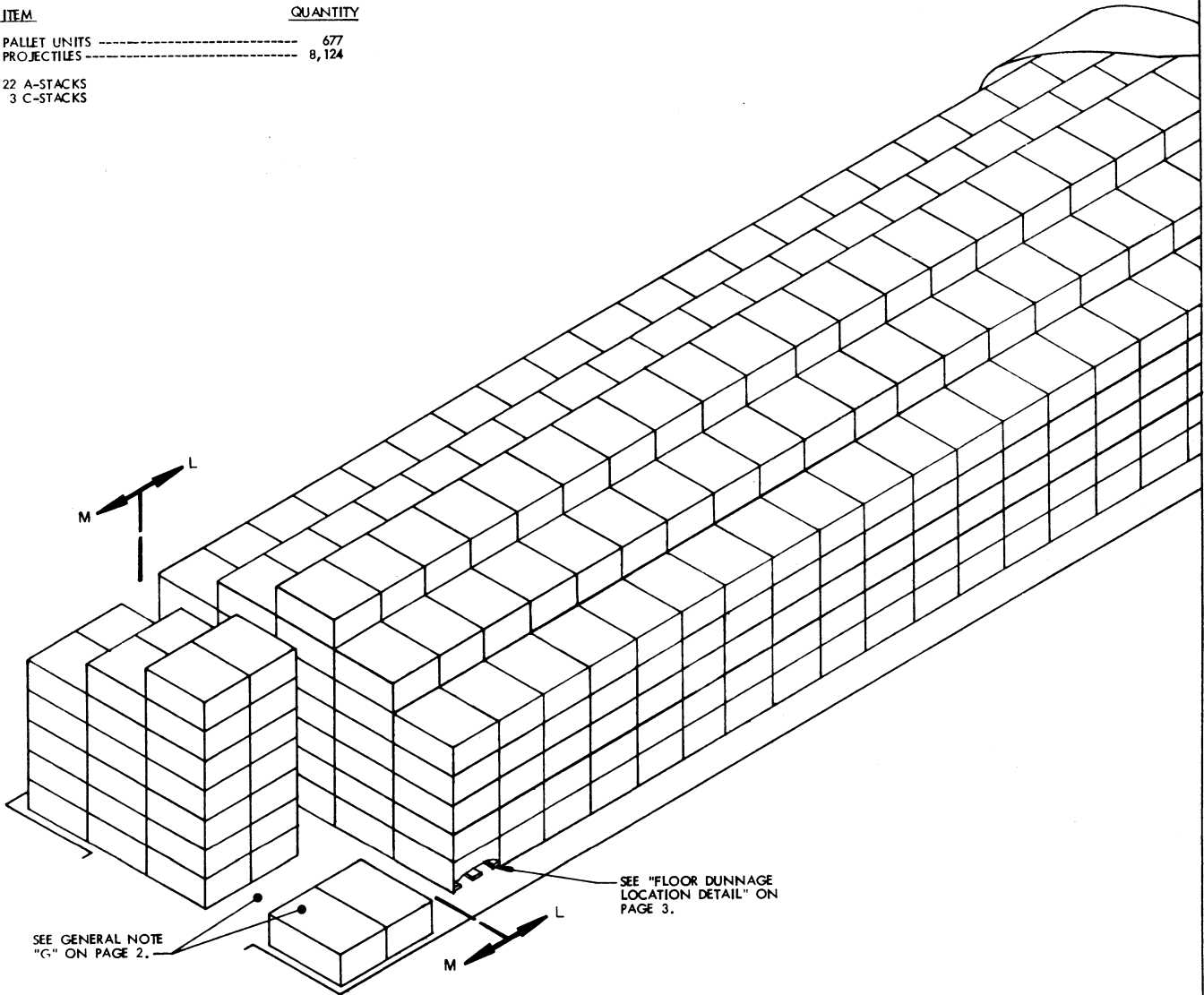

ISOMETRIC VIEW
(STRADLEY MAGAZINE)

FOR "GENERAL NOTES" AND "MATERIAL SPECIFICATIONS",
SEE PAGE 2.

BILL OF MATERIAL (PER STACK)**		
TYPE STACK	1" X 6" DUNNAGE LUMBER	
	LINEAR FEET	BOARD FEET
A	60.00	30.00
C	48.00	24.00

**SEE GENERAL NOTES "J" AND "K" ON PAGE 2.

SPECIAL NOTES:

1. FOR STORAGE IN OVAL ARCH MAGAZINES, THE ONE (1) ROW OF PALLET UNITS ADJACENT TO THE OPERATING AISLE AS SHOWN IN "SECTION M-M" MUST BE OMITTED AND ONE (1) PALLET UNIT CAN BE ADDED ON THE OPPOSITE SIDE OF THE OPERATING AISLE BECAUSE OF THE RELATIVELY NARROW DOOR OPENING. THIS WILL REDUCE THE "C" STACKS TO 13 UNITS EACH.
2. MORE PALLET UNITS THAN SHOWN IN THE STORAGE VIEWS ON PAGES 14 AND 15 CAN BE STORED IN A MAGAZINE, IF DESIRED AND IF THE MULTIPLE-LOT STORAGE CRITERIA OF GENERAL NOTE "O" IS NOT USED. ONE ADDITIONAL PALLET UNIT CAN BE PLACED INTO THE SIXTH LAYER OF EACH TYPE "A" STACK. TO PROVIDE CLEARANCE FOR AN ADDITIONAL UNIT IN A STACK, THE SIXTH-LAYER PALLET UNITS ARE TO BE SHIFTED SIDEWARD ONE-HALF PALLET WIDTH, RELATIVE TO THE PALLET UNITS WITHIN THE FIFTH LAYER.

STORAGE IN 52' DIA MAGAZINE

ITEM	QUANTITY
PALLET UNITS	400
PROJECTILES	5,856

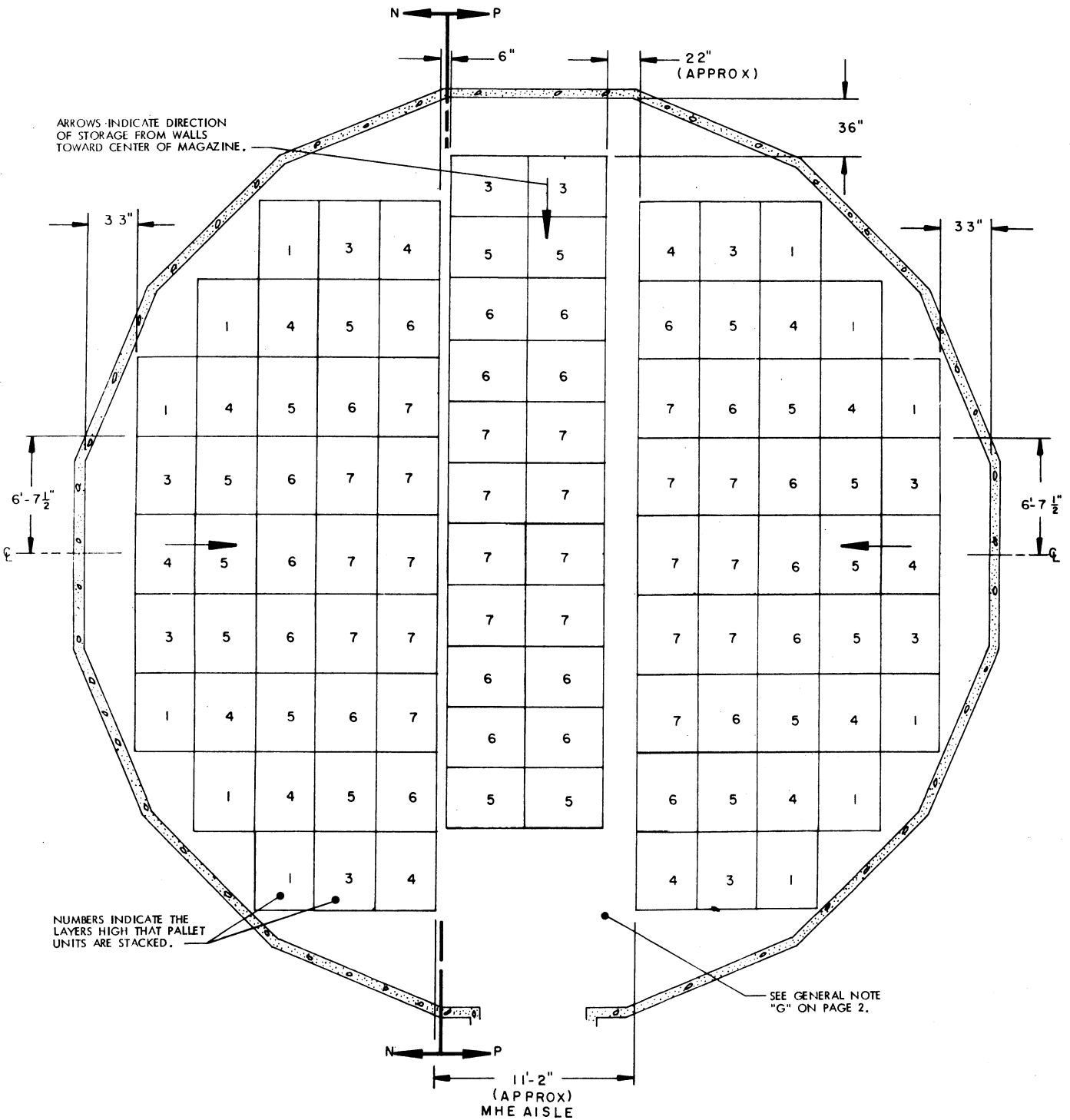

PLAN VIEW

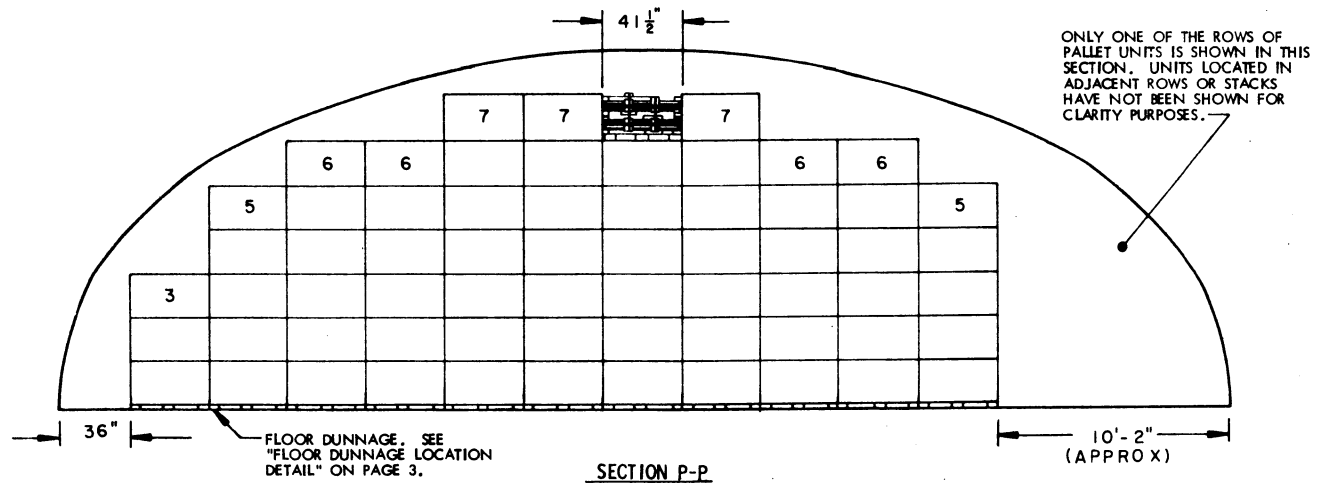
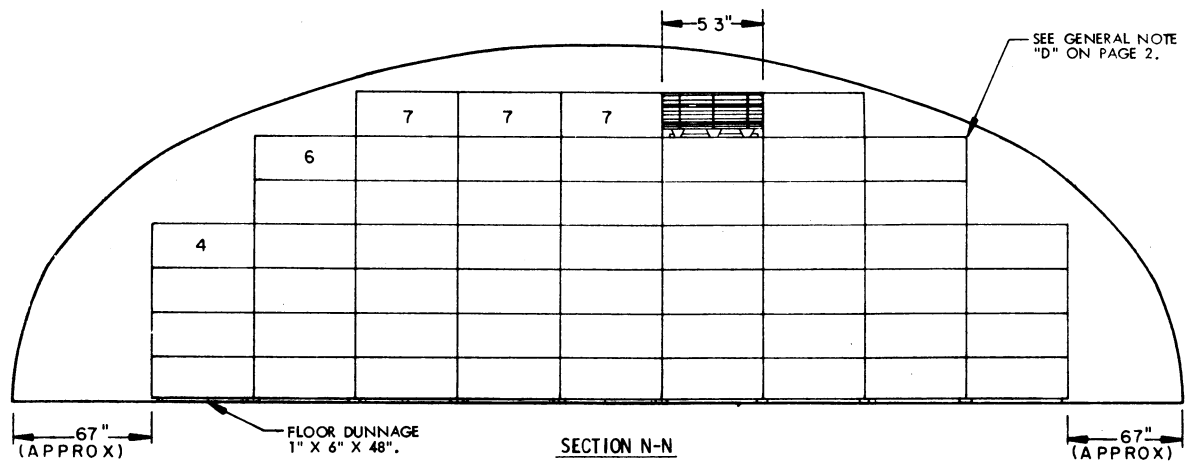

FOR "GENERAL NOTES" AND "MATERIAL SPECIFICATIONS",
SEE PAGE 2.

BILL OF MATERIAL (PER FIRST LAYER PALLET UNIT)*		
LUMBER	LINEAR FEET	BOARD FEET
1" X 6"	12.00	6.00

* SEE GENERAL NOTES "J" AND "K" ON PAGE 2.

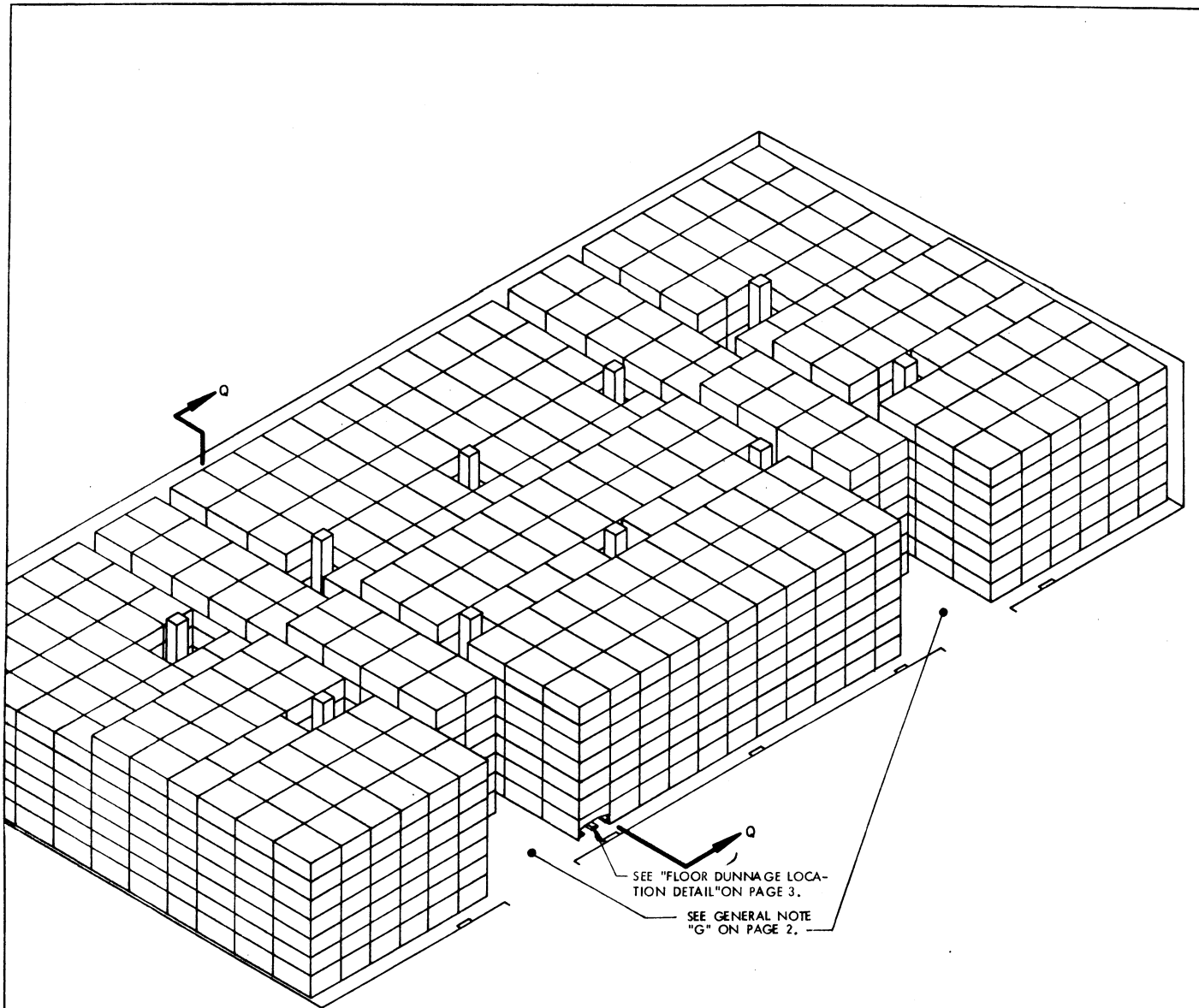

ISOMETRIC VIEW
(100' L X 50' W MAGAZINE)

FOR "GENERAL NOTES" AND "MATERIAL SPECIFICATIONS",
SEE PAGE 2.

BILL OF MATERIAL (PER FIRST LAYER PALLET UNIT)*		
LUMBER	LINEAR FEET	BOARD FEET
1" X 6"	12.00	6.00

*SEE GENERAL NOTES "J" AND "K" ON PAGE 2.

STORAGE IN 100' X 50' MAGAZINE

ITEM	QUANTITY
PALLET UNITS-----	1,769
PROJECTILES-----	21,228

SPECIAL NOTE:

IF THE QUANTITY FOR A MAGAZINE IS TO BE REDUCED FROM WHAT IS SHOWN - DUE TO THE PERMITTED "EXPLOSIVE LIMIT" OR FOR ANY OTHER REASON, SUCH AS A LIMITED QUANTITY TO BE STORED - THE DELINEATED PROCEDURES ARE TO BE ADJUSTED BY OMITTING STACKS RATHER THAN BY OMITTING LAYERS.

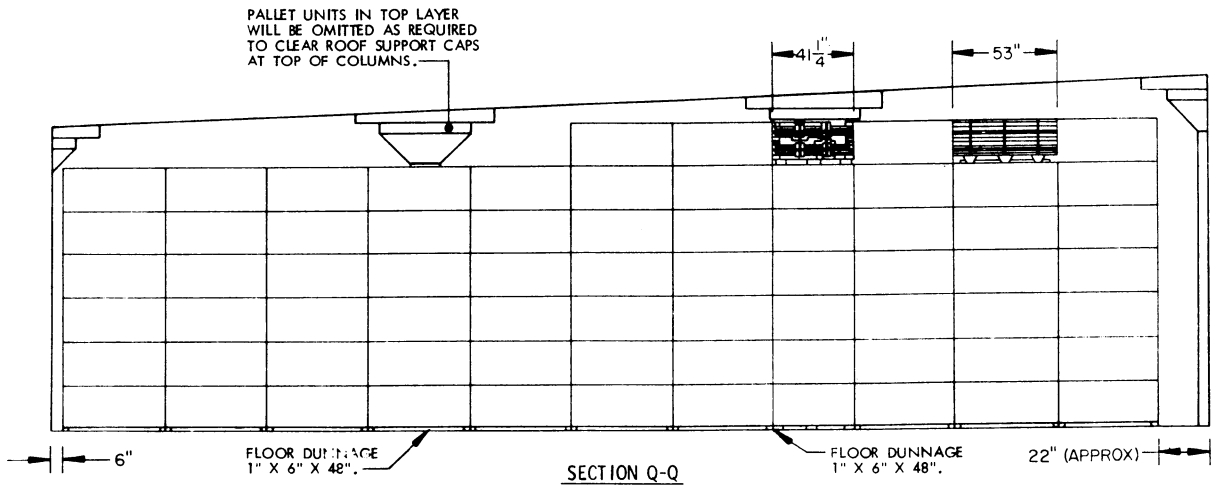
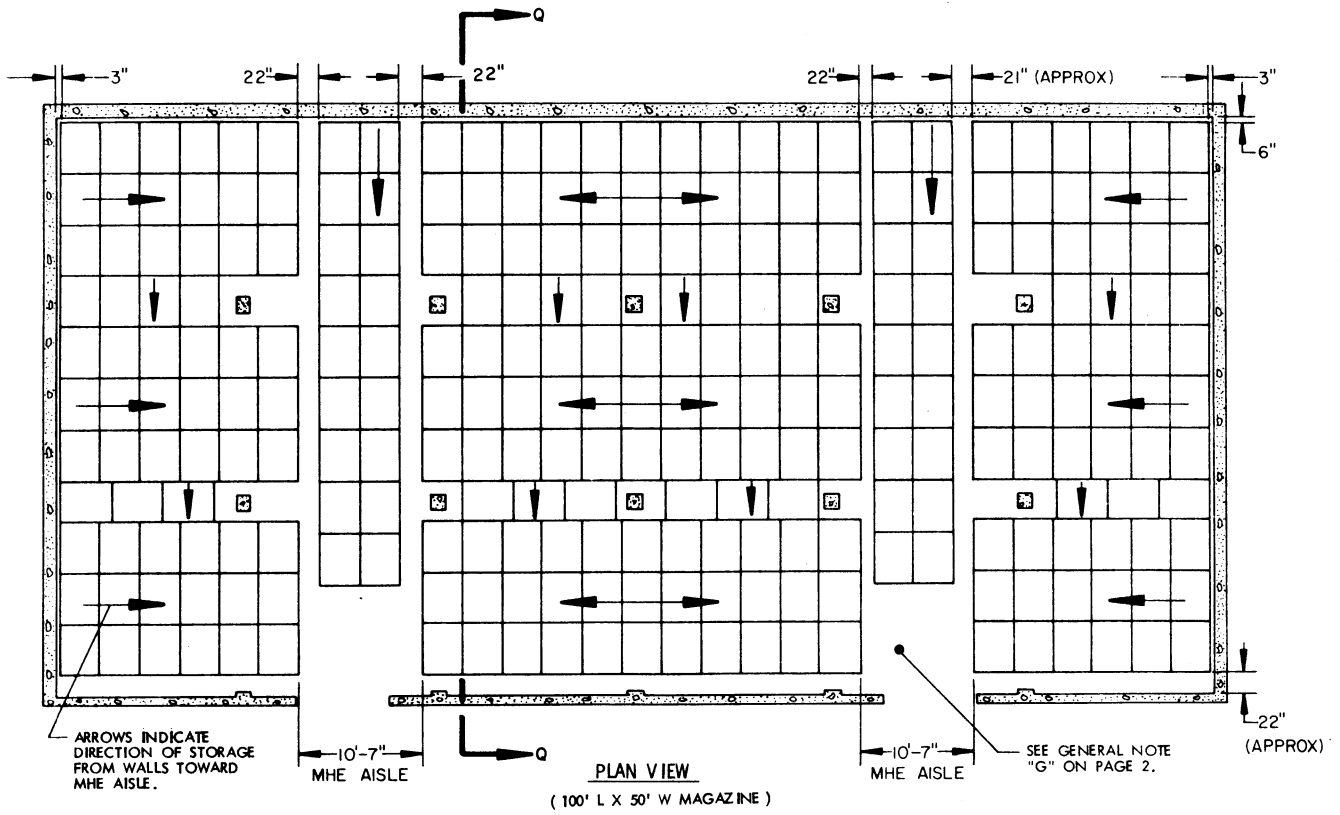

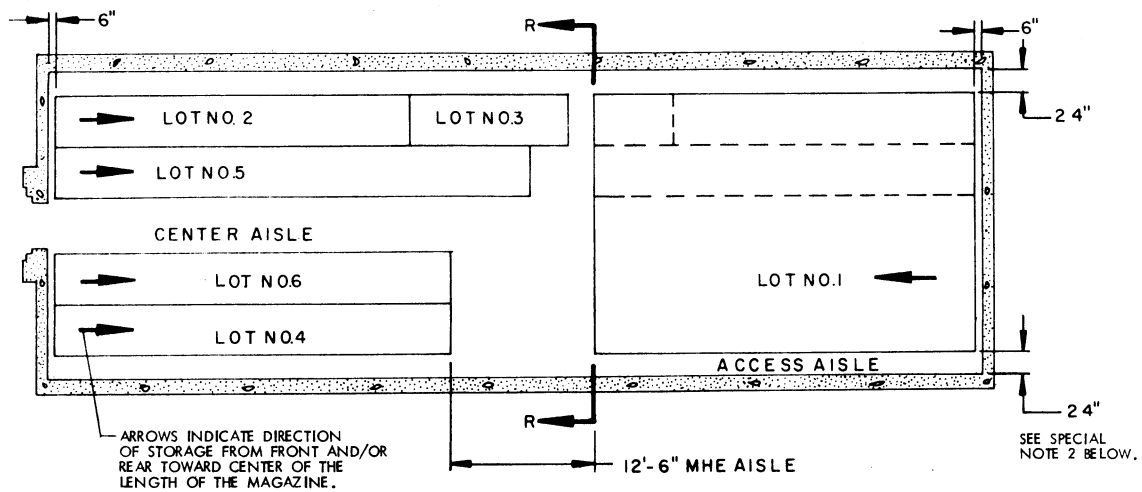

PLAN VIEW

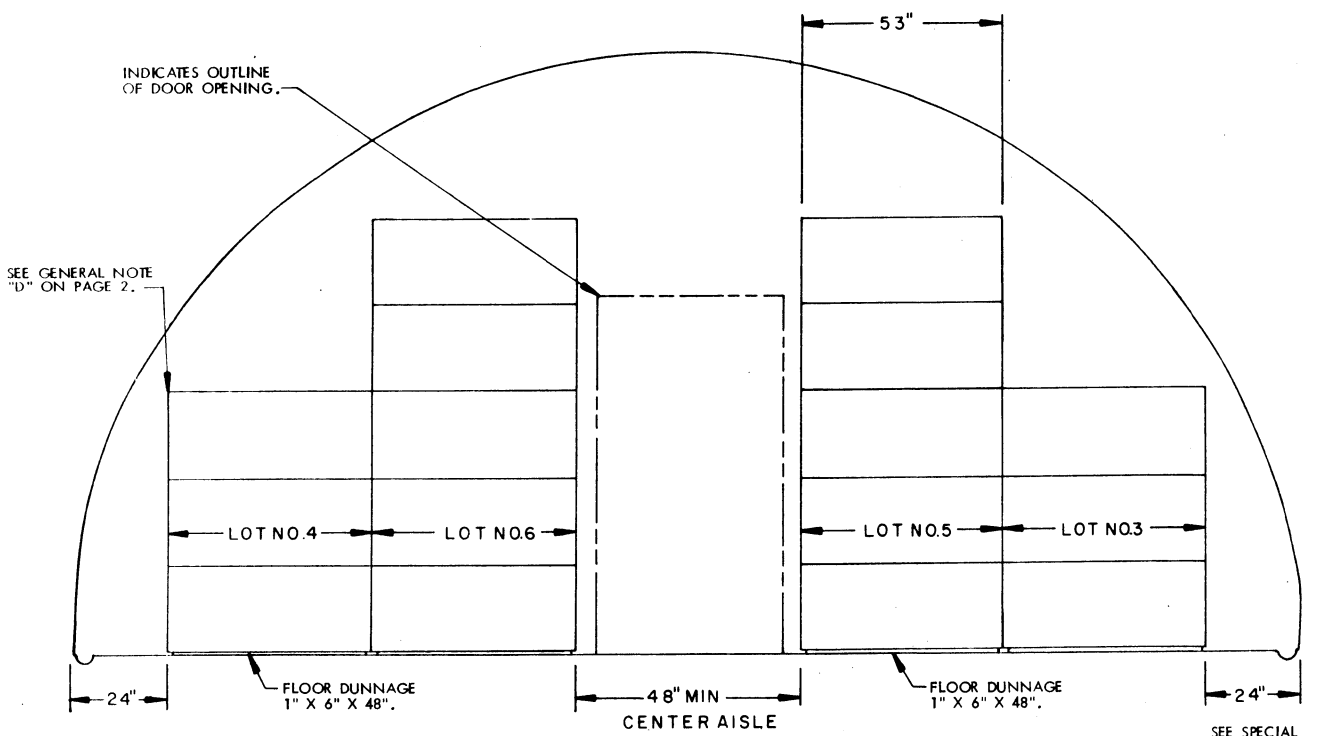

SECTION R-R

SPECIAL NOTES:

1. THE STORAGE PLANS AND CONFIGURATIONS SHOWN ON THIS PAGE ARE TYPICAL ONLY AND APPLY TO RELATIVELY LARGE LOTS. ADAPTATIONS MAY BE MADE AS NUMBER AND SIZES OF LOTS TO BE STORED IN MAGAZINE REQUIRE.
2. AN INSPECTION/INVENTORY AISLE MUST BE PROVIDED AT ONE SIDE OR END OF EACH LOT.
3. GENERALLY, THE LARGEST LOT SHOULD BE STORED IN THE REAR OF THE MAGAZINE. HOWEVER, THE REAR AREA MAY BE USED TO STORE MORE THAN ONE LOT BY ERECTING ROWS SIMILAR TO THOSE SHOWN IN THE FRONTAL AREA. A CENTER AISLE WILL NOT BE REQUIRED IN THE REAR AREA AS LONG AS EACH LOT IS ACCESSIBLE FOR REMOVAL AND INSPECTION/INVENTORY IN ACCORDANCE WITH OTHER CRITERIA SPECIFIED IN THESE SPECIAL NOTES AND IN THE GENERAL NOTES ON PAGE .
4. EACH LOT WITHIN THE MAGAZINE MUST BE ACCESSIBLE FOR MOVEMENT BY MHE. A SINGLE LOT OF PALLET UNITS IS CONSIDERED "ACCESSIBLE" IF NO MORE THAN TWELVE (12) "LIFTS" OF ANOTHER LOT OR LOTS HAVE TO BE MADE TO GAIN ACCESS TO THAT LOT. A "LIFT" MAY CONSIST OF ONE (1) OR MORE PALLET UNITS, PROVIDING THE CAPACITY OF MHE PERMITS, AND SAFE HANDLING IS NOT JEOPARDIZED.
5. FOR STORAGE OF MULTIPLE LOTS, THE DISTANCE FROM THE SIDEWALL WILL BE BASED ON THE OVERHEAD CLEARANCE REQUIRED FOR MHE.
6. WHEN TWO LOTS ARE STORED ADJACENT TO EACH OTHER, THEY SHOULD BE SEPARATED BY AT LEAST 1" TO PROVIDE CLEARANCE FOR REMOVAL OF EITHER LOT.

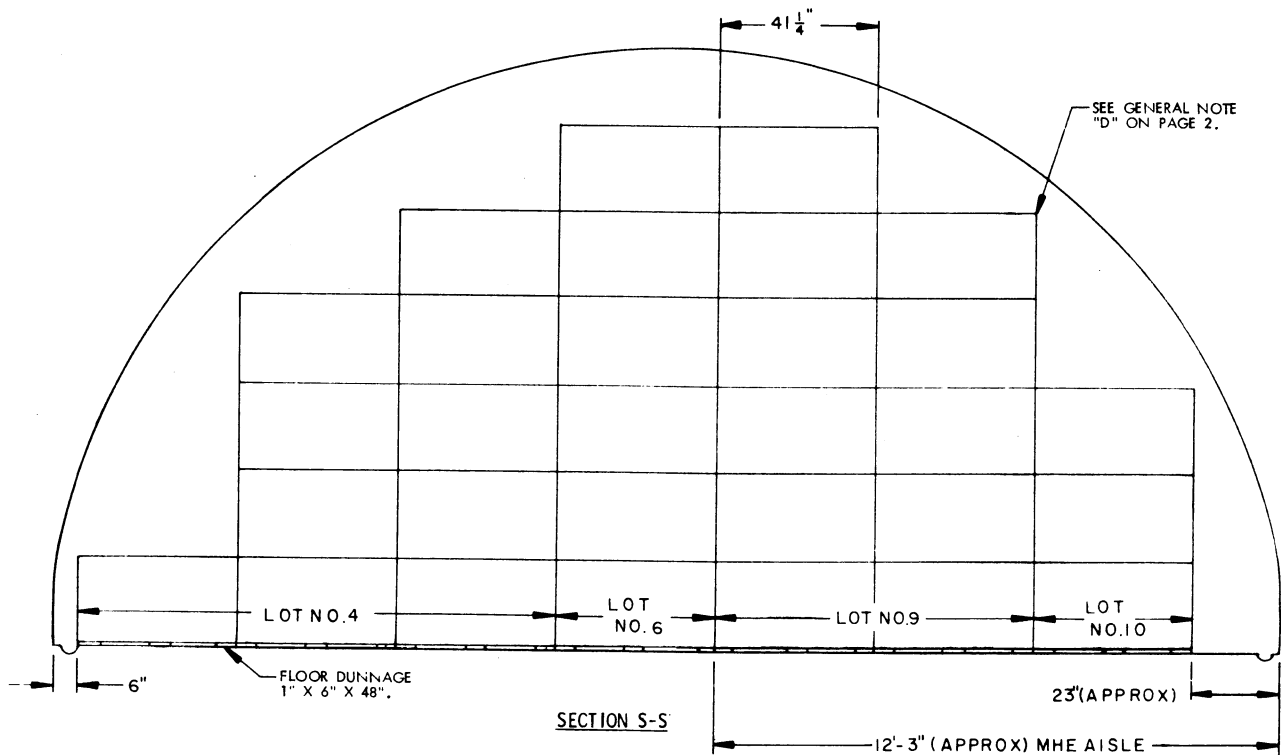
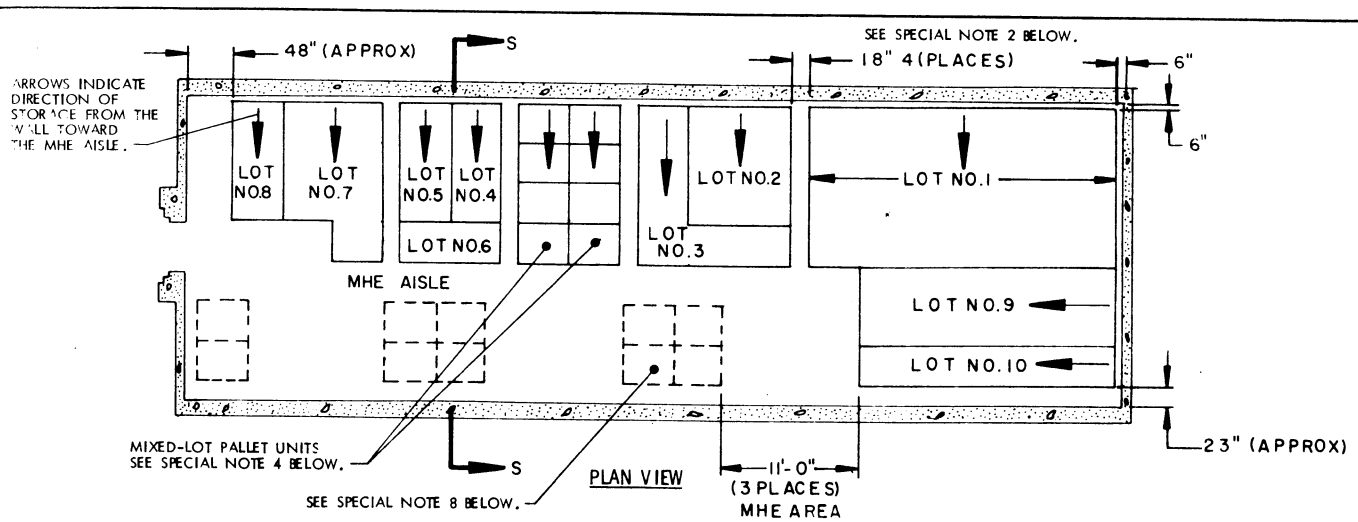

SPECIAL NOTES:

1. THE STORAGE PLANS AND CONFIGURATIONS SHOWN ON THIS PAGE ARE TYPICAL ONLY AND APPLY TO STORAGE OF NUMEROUS SMALL LOTS. ADAPTATIONS MAY BE MADE AS NUMBER AND SIZES OF LOTS TO BE STORED IN MAGAZINE REQUIRE.
2. AN INSPECTION/INVENTORY AISLE NOT LESS THAN 18" WIDE MUST BE PROVIDED AT ONE SIDE OF EACH "BURIED" LOT.
3. GENERALLY, THE LARGEST LOT SHOULD BE STORED IN THE REAR OF THE MAGAZINE. HOWEVER, THE REAR AREA MAY BE USED TO STORE MORE THAN ONE LOT BY ERECTING STACKS SIMILAR TO THOSE SHOWN IN THE FRONTAL AREA. AN MHE AISLE WILL BE REQUIRED ON ONE SIDE OF THE MAGAZINE, AND EACH LOT MUST BE ACCESSIBLE FOR REMOVAL AND INSPECTION/INVENTORY IN ACCORDANCE WITH OTHER CRITERIA SPECIFIED IN THESE SPECIAL NOTES AND IN THE GENERAL NOTES ON PAGE 2.
4. A MIXED-LOT PALLET UNIT MAY HAVE FROM TWO LOTS PER PALLET UNIT UPWARDS TO AS MANY DIFFERENT LOTS AS PROJECTILES WITHIN THAT UNIT. HOWEVER, ALL PROJECTILES AND LOTS WITHIN THE PALLET UNIT MUST HAVE THE SAME IDENTIFICATION STOCK NUMBER AND CONDITION CODE.
5. EACH LOT WITHIN THE MAGAZINE MUST BE ACCESSIBLE FOR MOVEMENT BY MHE. PALLET UNITS OF A SINGLE-LOT OR MIXED-LOT PALLET UNITS ARE CONSIDERED "ACCESSIBLE" IF NO MORE THAN TWELVE (12) "LIFTS" OF ANOTHER LOT OR LOTS HAVE TO BE MADE TO GAIN ACCESS TO THE SINGLE-LOT OR MIXED-LOT UNITS. A "LIFT" MAY CONSIST OF ONE (1) OR MORE PALLET UNITS, PROVIDING THE CRITERIA OF MHE PERMITS, AND SAFE HANDLING IS NOT JEOPARDIZED.
6. FOR STORAGE OF MULTIPLE LOTS, THE DISTANCE FROM THE SIDEWALL WILL BE BASED ON THE OVERHEAD CLEARANCE REQUIRED FOR MHE.

(CONTINUED AT RIGHT)

(SPECIAL NOTES CONTINUED)

7. WHEN TWO LOTS ARE STORED ADJACENT TO EACH OTHER, THEY SHOULD BE SEPARATED BY AT LEAST 1" TO PROVIDE CLEARANCE FOR REMOVAL OF EITHER LOT.
8. AREAS ENCLOSED BY DOTTED LINES INDICATE LOCATIONS WHERE ADDITIONAL LOTS MAY BE STORED OR WHERE ADDITIONAL ITEMS MAY BE STORED, THAT ARE FROM THE LOT OR LOTS WHICH ARE DIRECTLY OR ALMOST DIRECTLY ACROSS THE CENTER AISLE ON THE OTHER SIDE OF THE MAGAZINE. COMPLIANCE WITH ALL OF THE MULTIPLE-LOT CRITERIA AS SET FORTH ON THIS PAGE MUST BE OBSERVED. THE SIZE OF THE LOTS BEING STORED AND THE CRITERIA OF SPECIAL NOTE 5, RELATIVE TO "12 LIFTS", WILL BE MAJOR FACTORS IMPACTING ON THE NUMBER OF UNIT LOADS THAT CAN BE STORED IN AN "ADDITIONAL STORAGE LOCATION". MORE OR FEWER STACKS THAN SHOWN MAY BE STORED AT ANY ONE OF THE ADDITIONAL STORAGE LOCATIONS. AN 11-FOOT MHE OPERATING AREA HAS BEEN SPECIFIED FOR ACCESS TO EACH "ADDITIONAL LOCATION" BY FORKLIFT TRUCK. THIS OPERATING AREA IS BASED ON REQUIREMENTS OF FORKLIFT TRUCKS COMMONLY USED IN STORAGE MAGAZINES. THE MHE OPERATING AREA CAN BE ENLARGED AS REQUIRED TO SUIT AVAILABLE FORKLIFT TRUCKS, AND SHOULD BE MADE SMALLER IF AVAILABLE MHE PERMITS. A "CENTER AISLE" (SPACE BETWEEN STORAGE ON ONE SIDE OF A MAGAZINE AND AN "ADDITIONAL STORAGE LOCATION") IS TO BE AT LEAST 48 INCHES WIDE. AN AISLE SLIGHTLY WIDER THAN 48 INCHES WILL ENHANCE FORKLIFT TRUCK MOVEMENT WITHIN A MAGAZINE; HOWEVER, THIS AISLE SHOULD NOT BE MADE WIDER IF A LOSS IN STORAGE RESULTS.

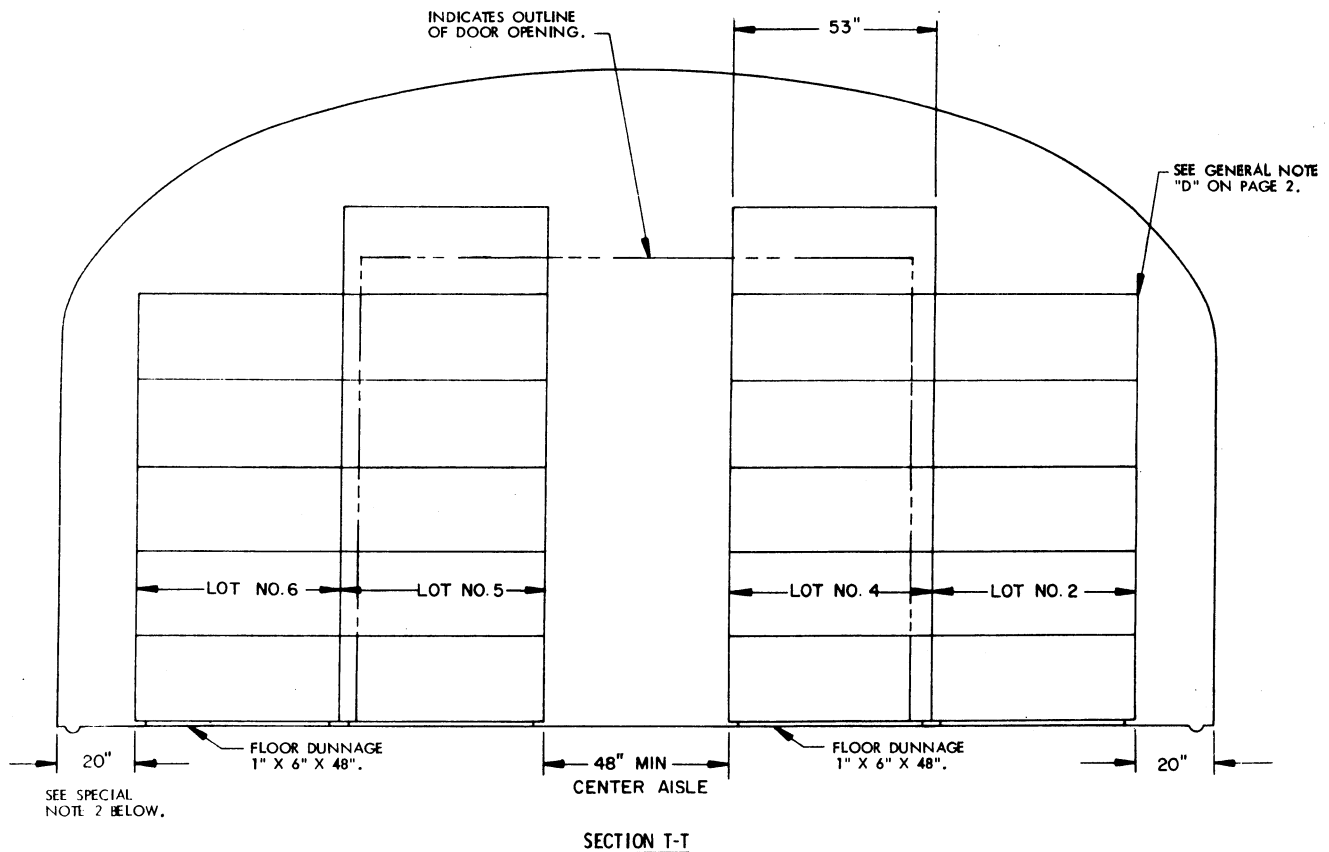
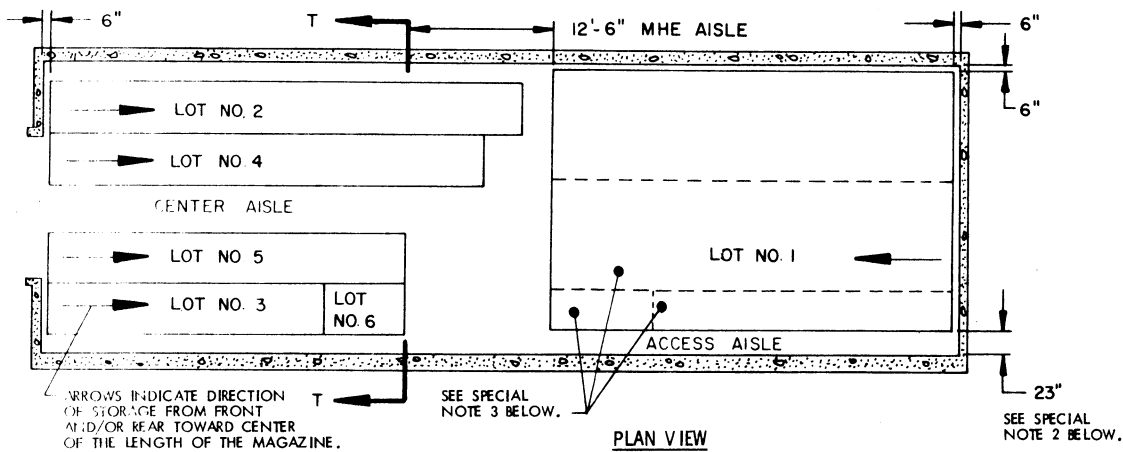

SPECIAL NOTES:

1. THE STORAGE PLANS AND CONFIGURATIONS SHOWN ON THIS PAGE ARE TYPICAL ONLY AND APPLY TO RELATIVELY LARGE LOTS. ADAPTATIONS MAY BE MADE AS NUMBER AND SIZES OF LOTS TO BE STORED IN MAGAZINE REQUIRE.
2. AN INSPECTION/INVENTORY AISLE MUST BE PROVIDED AT ONE SIDE OR END OF EACH LOT.
3. GENERALLY, THE LARGEST LOT SHOULD BE STORED IN THE REAR OF THE MAGAZINE. HOWEVER, THE REAR AREA MAY BE USED TO STORE MORE THAN ONE LOT BY ERECTING ROWS SIMILAR TO THOSE SHOWN IN THE FRONTAL AREA. A CENTER AISLE WILL NOT BE REQUIRED IN THE REAR AREA AS LONG AS EACH LOT IS ACCESSIBLE FOR REMOVAL AND INSPECTION/INVENTORY IN ACCORDANCE WITH OTHER CRITERIA SPECIFIED IN THESE SPECIAL NOTES AND IN THE GENERAL NOTES ON PAGE 2.
4. EACH LOT WITHIN THE MAGAZINE MUST BE ACCESSIBLE FOR MOVEMENT BY MHE. A SINGLE-LOT OF PALLET UNITS IS CONSIDERED "ACCESSIBLE" IF NO MORE THAN TWELVE (12) "LIFTS" OF ANOTHER LOT OR LOTS HAVE TO BE MADE TO GAIN ACCESS TO THAT LOT. A "LIFT" MAY CONSIST OF ONE (1) OR MORE PALLET UNITS, PROVIDING THE CAPACITY OF MHE PERMITS, AND SAFE HANDLING IS NOT JEOPARDIZED.
5. FOR STORAGE OF MULTIPLE LOTS, THE DISTANCE FROM THE SIDEWALL WILL BE BASED ON THE OVERHEAD CLEARANCE REQUIRED FOR MHE.
6. WHEN TWO LOTS ARE STORED ADJACENT TO EACH OTHER, THEY SHOULD BE SEPARATED BY AT LEAST 1" TO PROVIDE CLEARANCE FOR REMOVAL OF EITHER LOT.

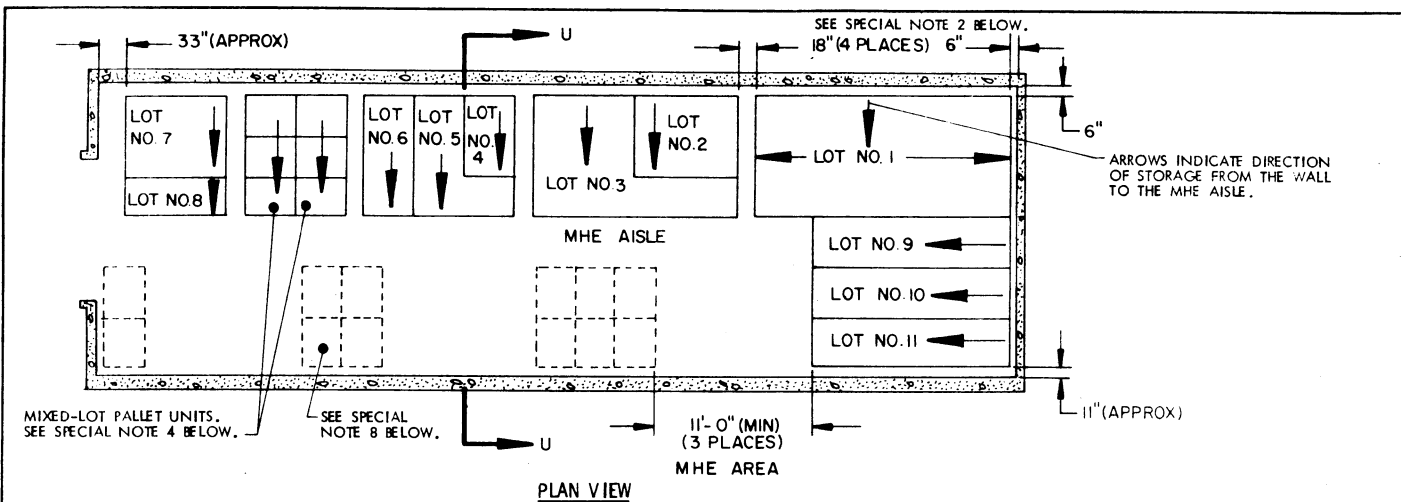

MIXED-LOT PALLET UNITS. SEE SPECIAL NOTE 4 BELOW.

SEE SPECIAL NOTE 8 BELOW.

11'-0" (MIN) (3 PLACES)
MHE AREA

ARROWS INDICATE DIRECTION OF STORAGE FROM THE WALL TO THE MHE AISLE.

PLAN VIEW

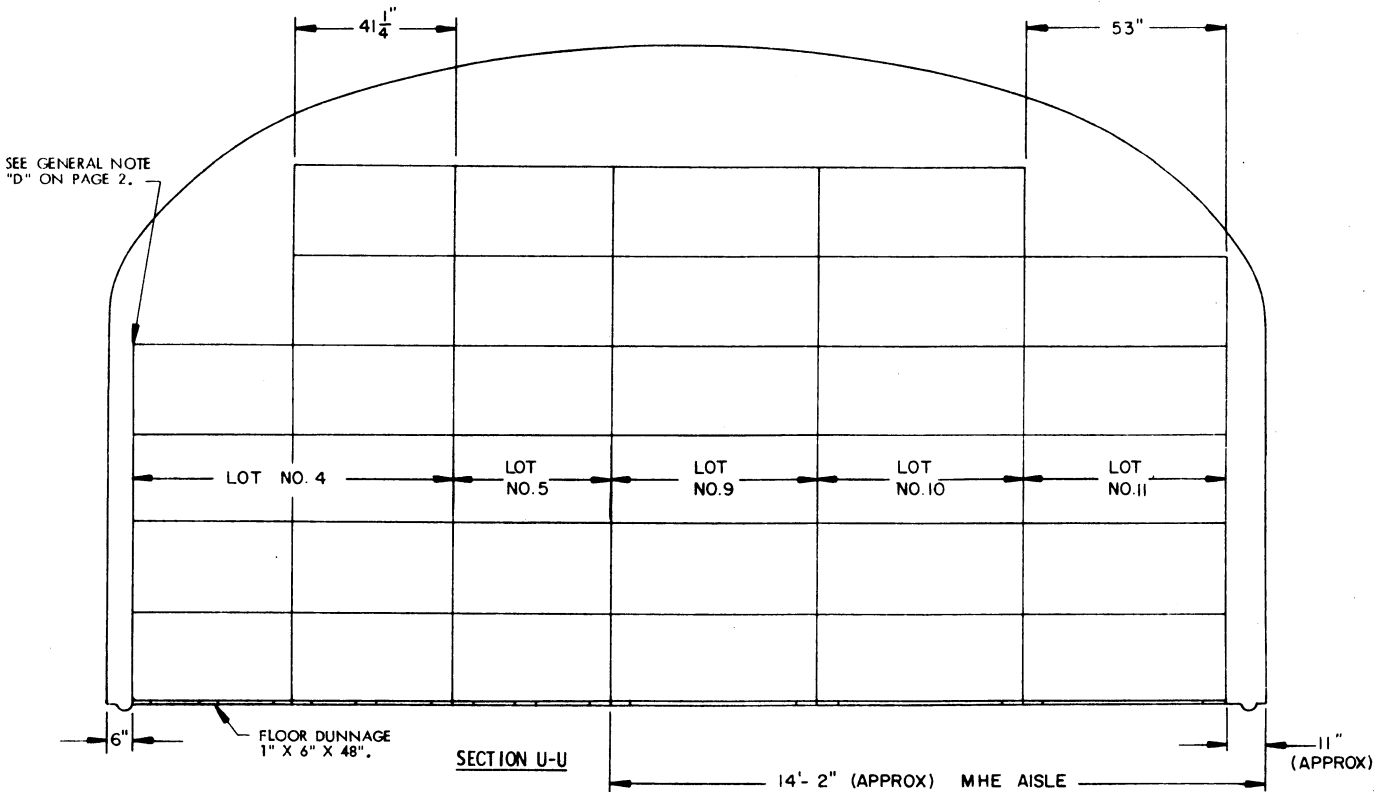

SEE GENERAL NOTE "D" ON PAGE 2.

FLOOR DUNNAGE 1" X 6" X 48".

SECTION U-U

14'-2" (APPROX) MHE AISLE

11" (APPROX)

SPECIAL NOTES:

1. THE STORAGE PLANS AND CONFIGURATIONS SHOWN ON THIS PAGE ARE TYPICAL ONLY AND APPLY TO STORAGE OF NUMEROUS SMALL LOTS. ADAPTATIONS MAY BE MADE AS NUMBER AND SIZES OF LOTS TO BE STORED IN MAGAZINE REQUIRE.
2. AN INSPECTION/INVENTORY AISLE NOT LESS THAN 18" WIDE MUST BE PROVIDED AT ONE SIDE OF EACH "BURIED" LOT.
3. GENERALLY, THE LARGEST LOT SHOULD BE STORED IN THE REAR OF THE MAGAZINE. HOWEVER, THE REAR AREA MAY BE USED TO STORE MORE THAN ONE LOT BY ERECTING STACKS SIMILAR TO THOSE SHOWN IN THE FRONTAL AREA. AN MHE AISLE WILL BE REQUIRED ON ONE SIDE OF THE MAGAZINE, AND EACH LOT MUST BE ACCESSIBLE FOR REMOVAL AND INSPECTION/INVENTORY IN ACCORDANCE WITH OTHER CRITERIA SPECIFIED IN THESE SPECIAL NOTES AND IN THE GENERAL NOTES ON PAGE 2.
4. A MIXED-LOT PALLET UNIT MAY HAVE FROM TWO LOTS PER PALLET UNIT UPWARDS TO AS MANY DIFFERENT LOTS AS PROJECTILES WITHIN THAT UNIT. HOWEVER, ALL PROJECTILES AND LOTS WITHIN THE PALLET UNIT MUST HAVE THE SAME NATIONAL STOCK NUMBER AND CONDITION CODE.
5. EACH LOT WITHIN THE MAGAZINE MUST BE ACCESSIBLE FOR MOVEMENT BY MHE. PALLET UNITS OF A SINGLE-LOT OR MIXED-LOT PALLET UNITS ARE CONSIDERED "ACCESSIBLE" IF NO MORE THAN TWELVE (12) "LIFTS" OF ANOTHER LOT OR LOTS HAVE TO BE MADE TO GAIN ACCESS TO THE SINGLE-LOT OR MIXED-LOT UNITS. A "LIFT" MAY CONSIST OF ONE (1) OR MORE PALLET UNITS, PROVIDING THE CAPACITY OF MHE PERMITS, AND SAFE HANDLING IS NOT JEOPARDIZED.

(CONTINUED AT RIGHT)

(SPECIAL NOTES CONTINUED)

6. FOR STORAGE OF MULTIPLE LOTS, THE DISTANCE FROM THE SIDEWALL WILL BE BASED ON THE OVERHEAD CLEARANCE REQUIRED FOR MHE.
7. WHEN TWO LOTS ARE STORED ADJACENT TO EACH OTHER, THEY SHOULD BE SEPARATED BY AT LEAST 1" TO PROVIDE CLEARANCE FOR REMOVAL OF EITHER LOT.
8. AREAS ENCLOSED BY DOTTED LINES INDICATE LOCATIONS WHERE ADDITIONAL LOTS MAY BE STORED OR WHERE ADDITIONAL ITEMS MAY BE STORED, THAT ARE FROM THE LOT OR LOTS WHICH ARE DIRECTLY OR ALMOST DIRECTLY ACROSS THE CENTER AISLE ON THE OTHER SIDE OF THE MAGAZINE. COMPLIANCE WITH ALL OF THE MULTIPLE-LOT CRITERIA AS SET FORTH ON THIS PAGE MUST BE OBSERVED. THE SIZE OF THE LOTS BEING STORED AND THE CRITERIA OF SPECIAL NOTE 5, RELATIVE TO "12 LIFTS", WILL BE MAJOR FACTORS IMPACTING ON THE NUMBER OF UNIT LOADS THAT CAN BE STORED IN AN "ADDITIONAL STORAGE LOCATION". MORE OR FEWER STACKS THAN SHOWN MAY BE STORED AT ANY ONE OF THE ADDITIONAL STORAGE LOCATIONS. AN 11-FOOT MHE OPERATING AREA HAS BEEN SPECIFIED FOR ACCESS TO EACH "ADDITIONAL LOCATION" BY FORKLIFT TRUCK. THIS OPERATING AREA IS BASED ON REQUIREMENTS OF FORKLIFT TRUCKS COMMONLY USED IN STORAGE MAGAZINES. THE MHE OPERATING AREA CAN BE ENLARGED AS REQUIRED TO SUIT AVAILABLE FORKLIFT TRUCKS, AND SHOULD BE MADE SMALLER IF AVAILABLE MHE PERMITS. A "CENTER AISLE" (SPACE BETWEEN STORAGE ON ONE SIDE OF A MAGAZINE AND AN "ADDITIONAL STORAGE LOCATION") IS TO BE AT LEAST 48 INCHES WIDE. AN AISLE SLIGHTLY WIDER THAN 48 INCHES WILL ENHANCE FORKLIFT TRUCK MOVEMENT WITHIN A MAGAZINE; HOWEVER, THIS AISLE SHOULD NOT BE MADE WIDER IF A LOSS IN STORAGE RESULTS.

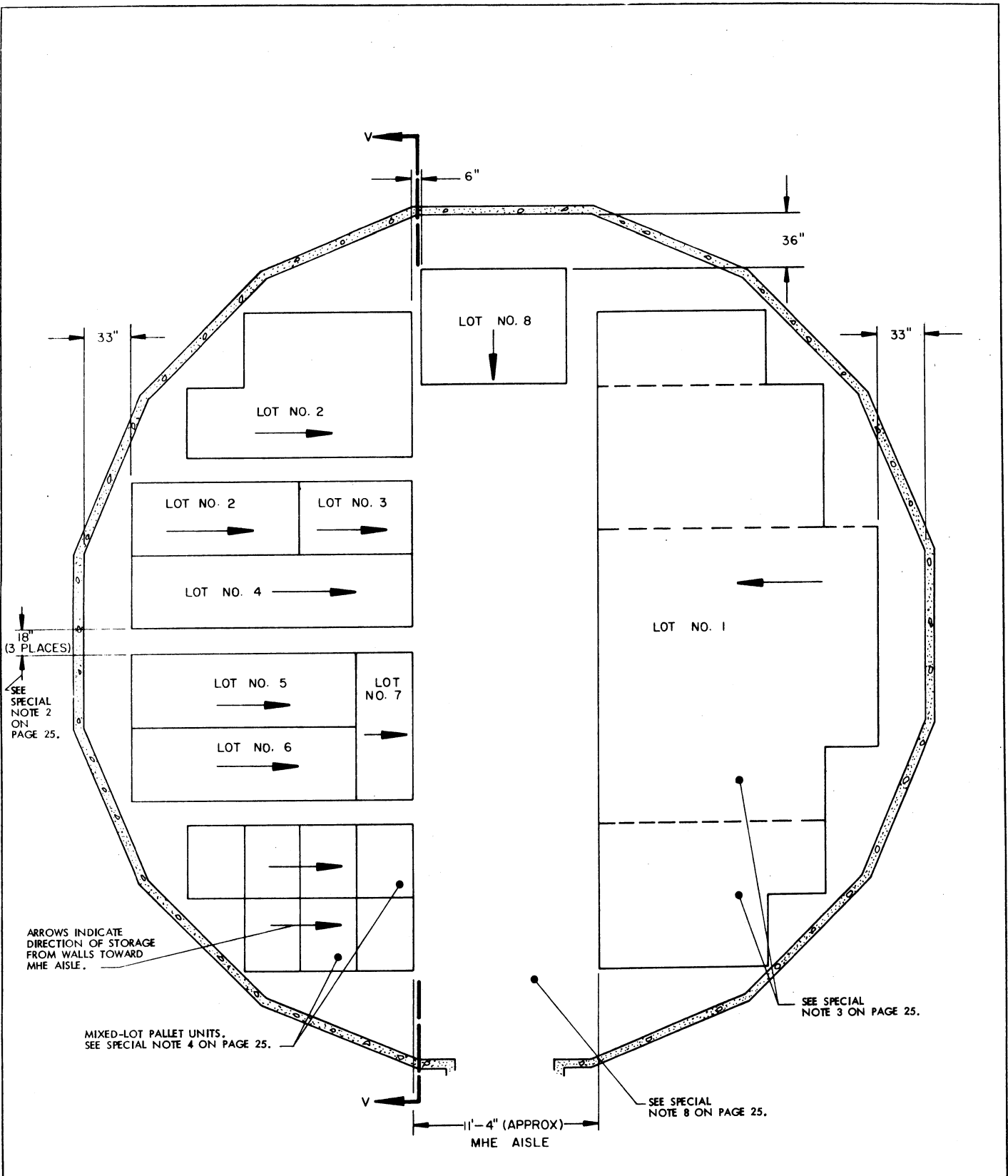

PLAN VIEW

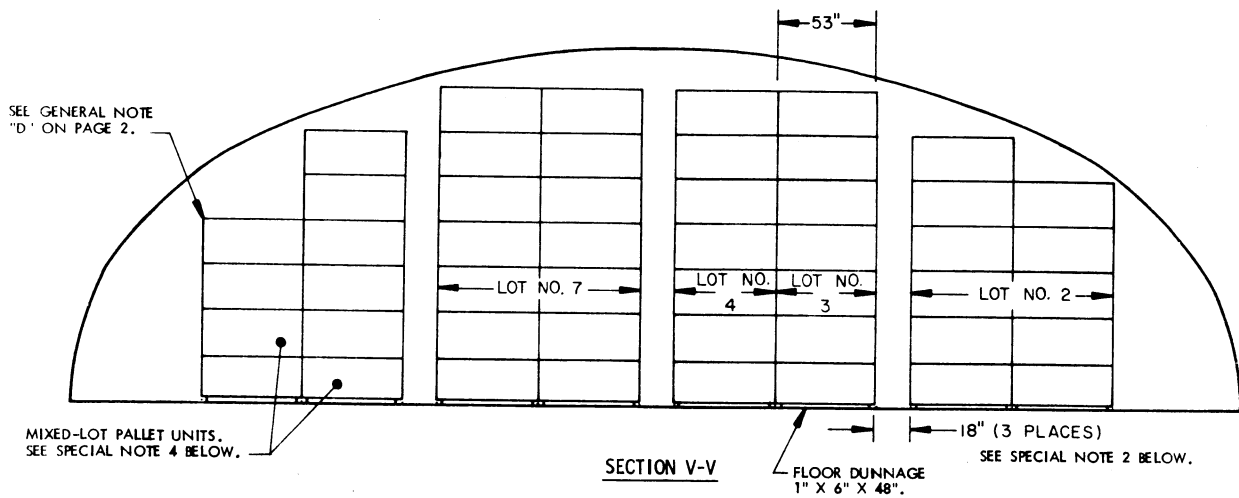

SPECIAL NOTES.

1. THE STORAGE PLANS SHOWN ARE TYPICAL ONLY. ADAPTATIONS MAY BE MADE AS NUMBER AND SIZES OF LOTS TO BE STORED IN MAGAZINE REQUIRE.
2. AN INSPECTION/INVENTORY AISLE NOT LESS THAN 18" WIDE MUST BE PROVIDED AT ONE SIDE OF EACH "BURIED" LOT.
3. GENERALLY, THE LARGEST LOT SHOULD BE STORED ON ONE SIDE OF THE MAGAZINE. HOWEVER, BOTH SIDES MAY BE USED TO STORE MORE THAN ONE LOT BY ERECTING ROWS SIMILAR TO THOSE SHOWN ON THE LEFT SIDE. EACH ADDITIONAL LOT MUST BE ACCESSIBLE FOR REMOVAL AND INSPECTION/INVENTORY IN ACCORDANCE WITH OTHER CRITERIA SPECIFIED IN THESE SPECIAL NOTES AND IN THE GENERAL NOTES ON PAGE 2.
4. A MIXED-LOT PALLET UNIT MAY HAVE FROM TWO LOTS PER PALLET UNIT UPWARDS TO AS MANY DIFFERENT LOTS AS PROJECTILES WITHIN THAT UNIT. HOWEVER, ALL PROJECTILES AND LOTS WITHIN THE PALLET UNIT MUST HAVE THE SAME NATIONAL STOCK NUMBER AND CONDITION CODE.
5. EACH LOT WITHIN THE MAGAZINE MUST BE ACCESSIBLE FOR MOVEMENT BY MHE. PALLET UNITS OF A SINGLE-LOT OR MIXED-LOT PALLET UNITS ARE CONSIDERED "ACCESSIBLE" IF NOT MORE THAN TWELVE (12) "LIFTS" OF ANOTHER LOT OR LOTS HAVE TO BE MADE TO GAIN ACCESS TO THE SINGLE-LOT OR MIXED-LOT UNITS. A "LIFT" MAY CONSIST OF ONE (1) OR MORE PALLET UNITS, PROVIDING THE CAPACITY OF MHE PERMITS, AND SAFE HANDLING IS NOT JEOPARDIZED.
6. FOR STORAGE OF MULTIPLE LOTS, THE DISTANCE FROM THE WALL WILL BE BASED ON THE OVERHEAD CLEARANCE REQUIRED FOR MHE.
7. WHEN TWO LOTS ARE STORED ADJACENT TO EACH OTHER, THEY SHOULD BE SEPARATED BY AT LEAST 1" TO PROVIDE CLEARANCE FOR REMOVAL OF EITHER LOT.
8. THE MHE AISLE MAY BE USED TO STORE ONE OR MORE STACKS OF ADDITIONAL LOTS OR ADDITIONAL ITEMS THAT ARE FROM A LOT ADJACENT TO THE MHE AISLE. THIS ADDITIONAL STORAGE IS TO BE ARRANGED IN A MANNER SIMILAR TO ARRANGEMENTS DEPICTED ON PAGES 21 AND 23 FOR THE "ADDITIONAL STORAGE LOCATIONS" (SHOWN BY DOTTED LINES). ADEQUATE SPACE FOR MHE OPERATION, AS DESCRIBED ON PAGES 21 AND 23, MUST BE MADE AVAILABLE FOR THE ADDITIONAL STORAGE. ALSO, COMPLIANCE WITH ALL OF THE MULTIPLE-LOT CRITERIA AS SET FORTH ON THIS PAGE MUST BE OBSERVED.

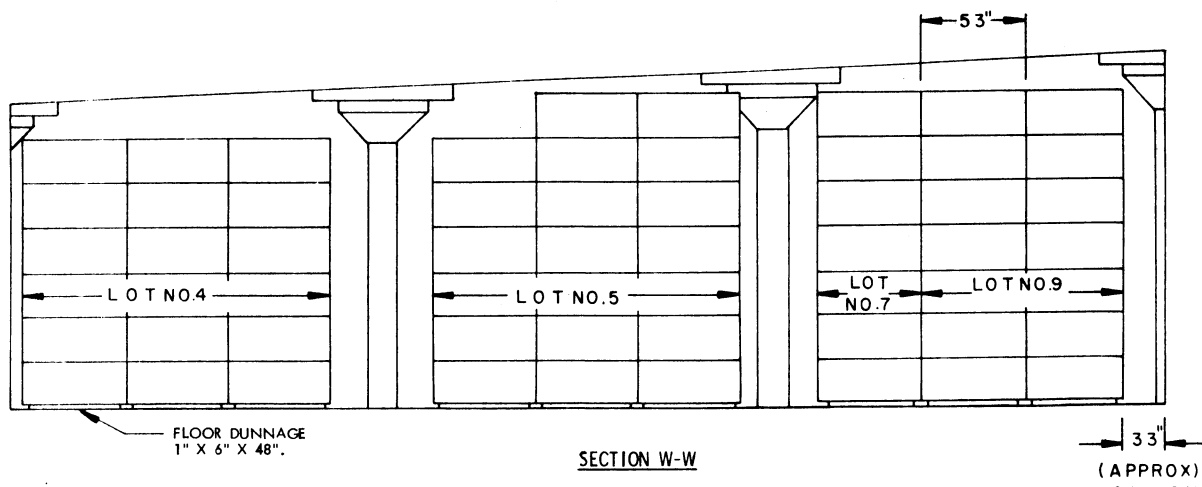
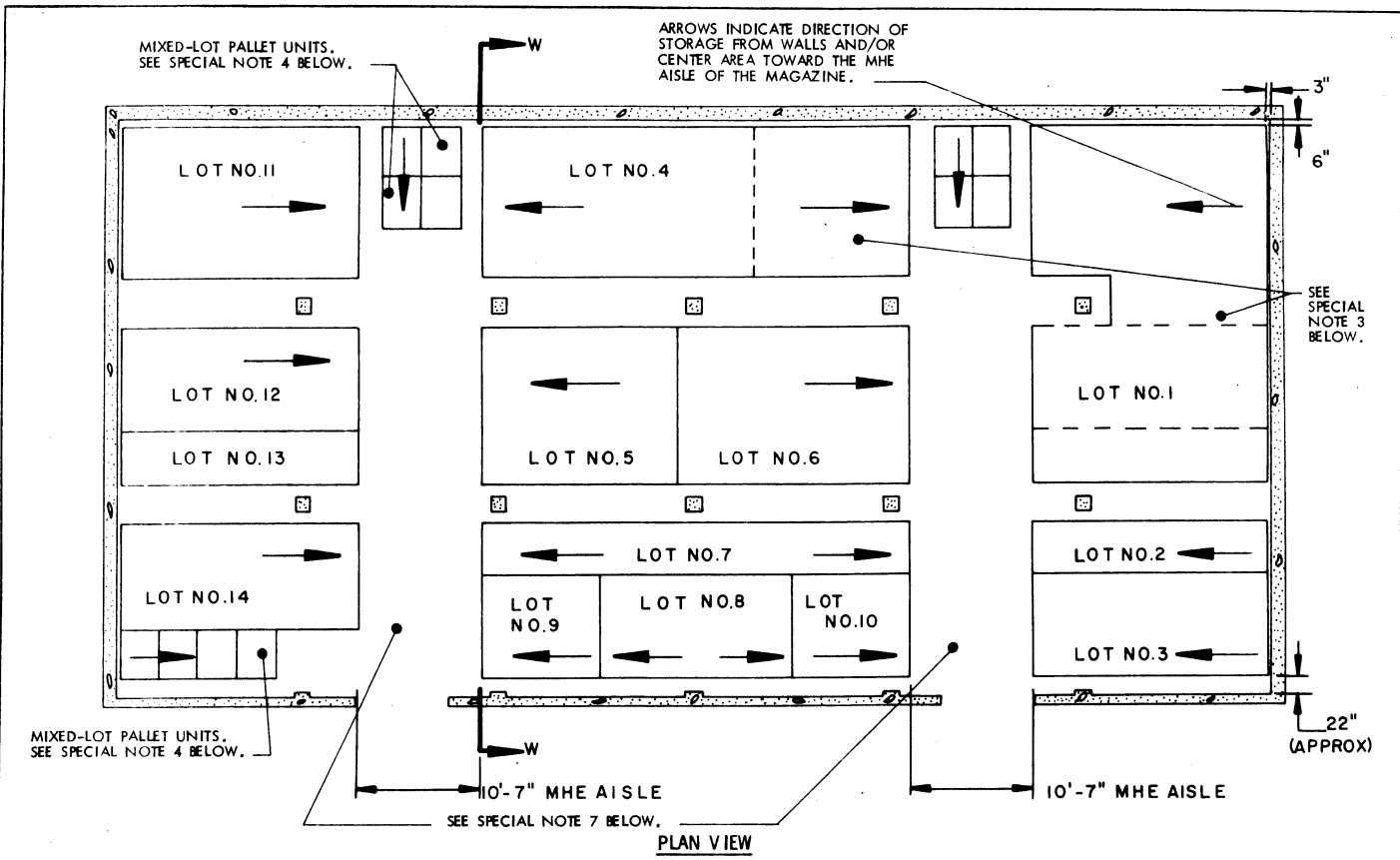

SPECIAL NOTES:

1. THE STORAGE PLANS SHOWN ARE TYPICAL ONLY. ADAPTATIONS MAY BE MADE AS NUMBER AND SIZES OF LOTS TO BE STORED IN MAGAZINE REQUIRE.
2. AN INSPECTION/INVENTORY AISLE NOT LESS THAN 18" WIDE MUST BE PROVIDED AT ONE SIDE OF EACH "BURIED" LOT.
3. GENERALLY, THE LARGEST LOT SHOULD BE STORED IN THE REAR OR ON ONE SIDE OF THE MAGAZINE. HOWEVER, THESE AREAS MAY BE USED TO STORE MORE THAN ONE LOT BY ERECTING ROWS SIMILAR TO THOSE SHOWN IN THE CENTER AREA OR AS TYPICALLY INDICATED BY DOTTED LINES. EACH ADDITIONAL LOT MUST BE ACCESSIBLE FOR REMOVAL AND INSPECTION/INVENTORY IN ACCORDANCE WITH OTHER CRITERIA SPECIFIED IN THESE SPECIAL NOTES AND IN THE GENERAL NOTES ON PAGE 2.
4. A MIXED-LOT PALLET UNIT MAY HAVE FROM TWO LOTS PER PALLET UNIT UPWARDS TO AS MANY DIFFERENT LOTS AS PROJECTILES WITHIN THAT UNIT. HOWEVER, ALL PROJECTILES AND LOTS WITHIN THE PALLET UNIT MUST HAVE THE SAME NATIONAL STOCK NUMBER AND CONDITION CODE.
5. EACH LOT WITHIN THE MAGAZINE MUST BE ACCESSIBLE FOR MOVEMENT BY MHE. PALLET UNITS OF A SINGLE-LOT OR MIXED-LOT PALLET UNITS ARE CONSIDERED "ACCESSIBLE" IF NO MORE THAN TWENTY-FOUR (24) "LIFTS" OF ANOTHER LOT OR LOTS HAVE TO BE MADE TO GAIN ACCESS TO THE SINGLE-LOT OR MIXED-LOT UNITS. A "LIFT" MAY CONSIST OF ONE (1) OR MORE PALLET UNITS, PROVIDING THE CAPACITY OF MHE PERMITS, AND SAFE HANDLING IS NOT JEOPARDIZED.

(CONTINUED AT RIGHT)

(SPECIAL NOTES CONTINUED)

6. WHEN TWO LOTS ARE STORED ADJACENT TO EACH OTHER, THEY SHOULD BE SEPARATED BY AT LEAST 1" TO PROVIDE CLEARANCE FOR REMOVAL OF EITHER LOT.
7. THE MHE AISLE MAY BE USED TO STORE ONE OR MORE STACKS OF ADDITIONAL LOTS OR ADDITIONAL ITEMS THAT ARE FROM A LOT ADJACENT TO THE MHE AISLE. THIS ADDITIONAL STORAGE IS TO BE ARRANGED IN A MANNER SIMILAR TO ARRANGEMENTS DEPICTED ON PAGES 21 AND 23 FOR THE "ADDITIONAL STORAGE LOCATIONS" (SHOWN BY DOTTED LINES). ADEQUATE SPACE FOR MHE OPERATION, AS DESCRIBED ON PAGES 21 AND 23, MUST BE MADE AVAILABLE FOR THE ADDITIONAL STORAGE. ALSO, COMPLIANCE WITH ALL OF THE MULTIPLE-LOT CRITERIA SET FORTH ON THIS PAGE MUST BE OBSERVED.